

Project design on 24 hour family based solar cooker.

MOLTEN SALT SOLAR COOKER

Jitendra kumar Dash, Omprakash Parida, Swastik Tripathy and Sagar Dutta.

Department of Electrical and Electronics Engineering,

Silicon Institute of Technology, Bhubaneswar, India-751024.

Email-tpy.swastik@gmail.com

ABSTRACT:

Solar cooking technology has to undergo a sea change if at all it's to be accepted as the main source of cooking Energy. This is why a better model that incorporates both the traditional heat trapping cum concentrator mechanism and the latest techniques like that which uses a solar battery (phase change materials with high heat retention capability) can be used as the basic idea for the purpose.

A multi-purpose hybrid solar cooker using locally available materials can be used for night as well as day cooking. It will have two way supply of heat directly from sun during day time for cooking and from the phase change material during night time. This cooker preferably provides indoor cooking and it can have two arrangements, namely Grill and Oven, for cooking various Indian foods.

Sufficient care was taken for selecting the materials to be used in this solar cooker with price and availability constraints across rural India. The design ideally can cook two traditional meals a day for a family of five. All assumptions for the design are based on this basic aim.

INTRODUCTION:

Solar cooking with all its benefits, starting from environment-friendliness to its cost effectiveness, is yet to be accepted as a viable option for cooking. The main reason for this can be traced out as;

1. Cooking occurs only in sunshine hours.
2. No ease of cooking as the user has to wait longer for simple cooking processes like boiling.
3. Limited number of dishes that can be cooked.

While in the day time cooking will not be an issue, for the night there has to be some form of back-up energy stored throughout the day. This is achieved by selecting a material that has high heat retention capability.

However recent studies show that sensible heating is not the option, even if the material has a high Specific Heat. This is why we opted for Latent Heat storage using phase change materials. Latent heat storage is a relatively new area of research which can be used for

storing heat by changing the phase of the material (phase change material-PCM) without rise in its temperature.

To improve the ease of cooking one must separate the traditional model of a solar cooker that has its absorber, cooking surface and heat storage system all jammed to the same place. We can implement the design by having an outdoor arrangement for heat absorption and storage that includes the Phase Change Material, a heat exchanger with water-glycol solution as its fluid which is regulated by a condenser and steam tank, and finally an indoor cooker installed inside the kitchen.

DESIGN AND DIFFERENT PARTS:

The required arrangement can be envisioned using a block diagram as below:

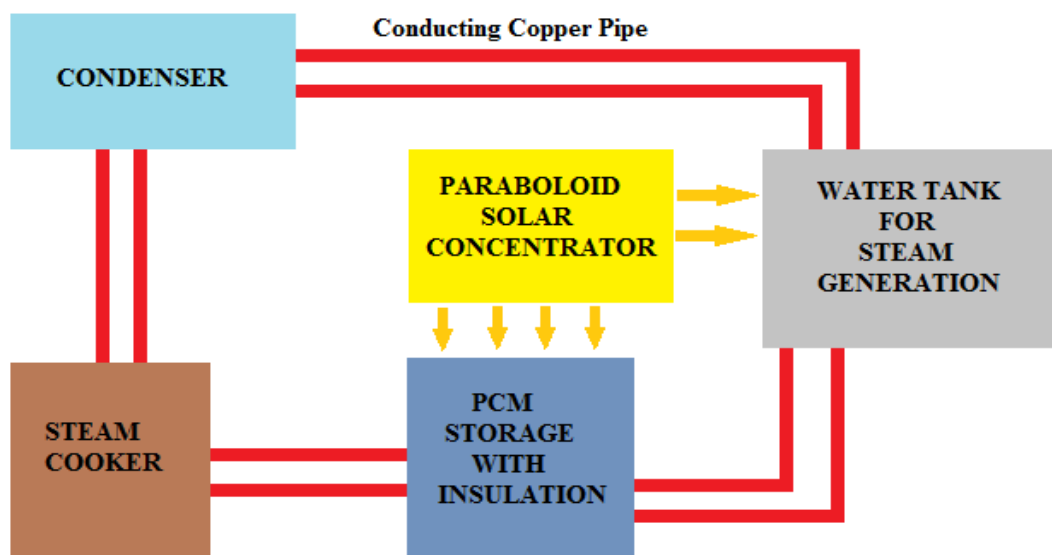

Block Diagram for the Design

The different parts of the Molten Salt Solar Cooker are:

(a) SOLAR CONCENTRATOR:

Solar concentrators are an indispensable part of any solar cooking project. Depending on the aperture they can produce different levels of heat at their Focal points. Our design requires these concentrators to focus to such an extent that they are capable to produce almost 800 °C of temperature at the absorber end.

Thus we had to reject low level concentration schemes like lenses or plane reflectors for the ones like parabolic concentrators.

In a minimum of two parabolic solar concentrators are proposed in this solar cooker. The parabolic is to be made up of aluminium and its back surface is coated with black colour. This kind of concentrator is known as Scheffler concentrator. This concentrator can be used to generate a very high temperature.

*In a project in Rajasthan it is practically observed that,

2.7 m² of Scheffler concentrator can bring 1.2lts of water to boiling point within 10mins

From that we get the amount of heat in 10min= $MC_wdT=376.2\text{kJ}$

Hence in 1 minute such a Scheffler concentrator can supply heat=37.6kJ

We will later on Derive the heat required for a family of five to cook two traditional meals a day by taking a safe margin for losses as 10MJ.(from the calculation given below with reference to the data from FAO)

Thus the time required to store this required energy assuming proper insulation

= $10\text{MJ} / (37.6\text{kJ}/\text{min})=265.95\text{min}$.

If we use two such concentrators then the time required is a half of the above

= $265.95/2 \text{ min}= 132.97 \text{ min}= 2.21\text{hrs}$.

Thus two 2.7m² Scheffler reflectors will take almost two and a half hours of sunlight.

By using four such reflectors in four sides of the absorber we may increase the cost complexity but we will also have three concrete advantages-

1. Less time required for storing the net daily Energy requirement.
2. Increase the possibility of taking the used salt to molten temperatures (800 °C), as we will see later on.
3. Minimal requirement throughout the day for the users to track the sun for adjustment of foci.

The fact that Scheffler reflectors of 8m² size nowadays have shown to generate almost 1000 °C at the focus makes another option for improvement of the design.

(b)WATER TANK:

This unit will be useful in two ways-

1. Storing of heat exchange material that is, water for their high retention capability.
2. Providing the starting energy required to cook in the morning when no energy is there inside the PCM.

The water tank is made up of stainless steel and having a carbon black Paint coating in the outer surface because of its high absorptance to emissivity ratio. Again sufficient glazing is also a requirement.

Inside the tank there is a copper coil for better conduction of heat. The water tank is located in the focal point of a parabolic surface.

During day the water tank absorbs heat and the water is converted to steam which passes through the heat exchanger of the solar cooker. The copper pipe is arranged in a coiled form to increase heat flow. This arrangement will ensure that the cooker can start in the morning itself so that the user need not wait till the PCM heats up. This provides an additional supply for day cooking.

The diagrammatic representation of this is as below:

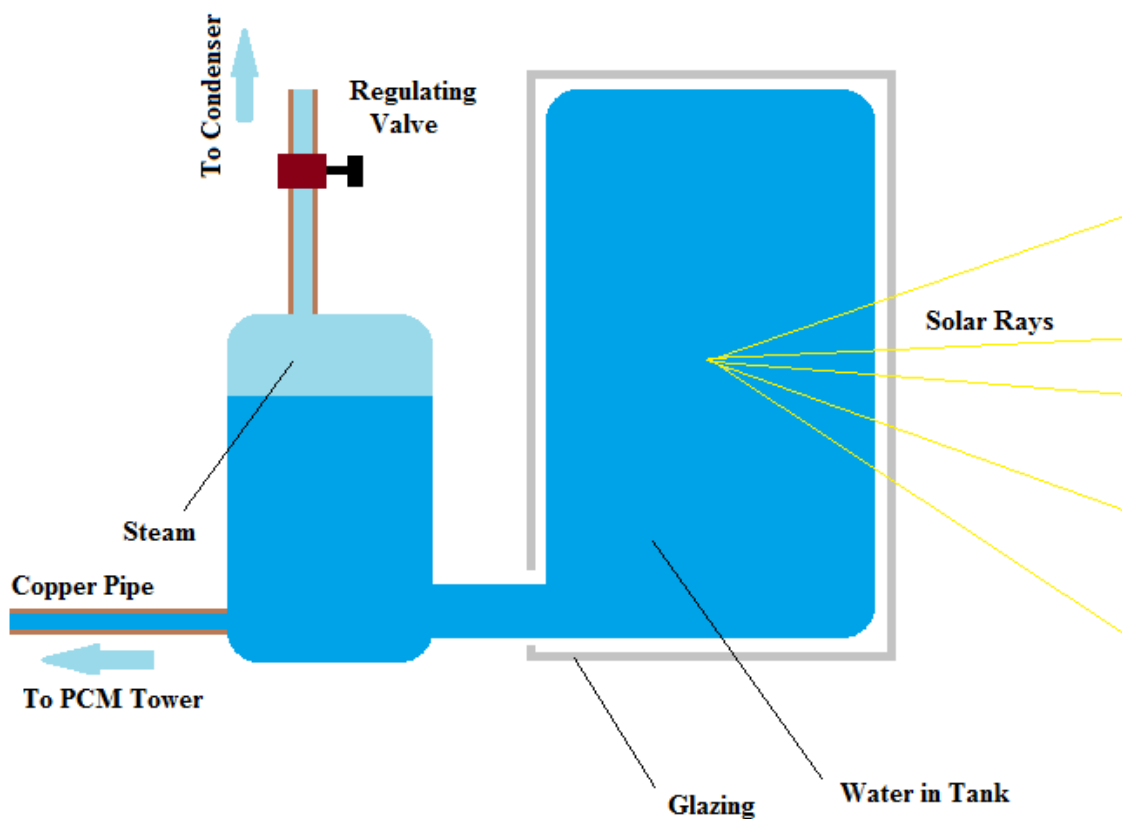

The tank is kept at the ground level so that the steam generated will automatically go up to the condenser without the help of a pump. However for practical feasibility of cooking process we may encounter the need for a pump for faster circulation. The Copper pipes help in the convection of heat to the PCM tower.

The Steam is collected in the portion left vacant in the secondary tank. The primary water tank is used for glazed heating. The steam supply to the condenser is regulated by a valve as it is only needed while cooking.

The PCM tower has another valve to be opened in the beginning of the day to initiate heating of Salt.

(c)PCM STORAGE WITH INSULATION:

* Heat retention works the best for materials with impressive Specific Heat Capacities. But this is just the half story. While retention does depend upon Heat Capacity another factor that comes to play is conductivity. Under high temperature regions, sensible heat materials are not so good conductors.

That is why Phase Change Materials (PCM) are the best bet for Heat retention. Successfully, many designers have used Nitrate salts and acetanyline for this purpose. However, as it seems for our requirements they may not be suitable. For example Lithium Nitrate is not at all available in many regions across India, even though it may have an impressive Latent Heat.

However the Nitrate Salts have to be rejected on the ground that they are unavailable and at the same time are known to yield explosive.

*This is where Sodium Chloride stands a chance because of availability. However, to be used as a Phase Change Material Sodium Chloride has to be raised to its melting point of 802°C. With a specific heat capacity of 492kj/kg Heat retention is not a problem for Sodium Chloride.

Though achieving its molten state will be a tedious task, given that we get there we will need a highly insulated chamber to store the excess heat. By using concentrators surrounding NaCl in all four directions, we can hope to achieve this molten state within a tower like arrangement as shown below;

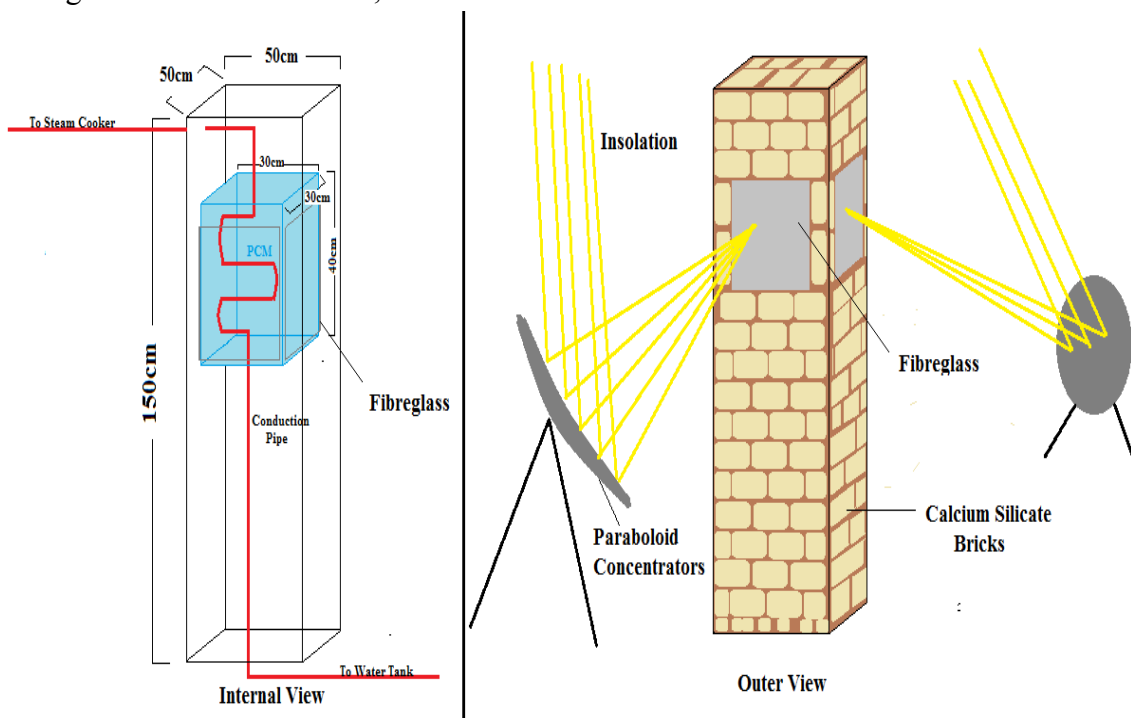

As shown above, The Sodium Chloride will be concentrated by radiation through the fibreglass glazing material. This PCM tower is made up of Calcium Silicate bricks with reinforcement for insulation. A space for airgap is left in the chamber containing the Salt keeping in mind that NaCl will expand with temperature. After the melting is reached the molten NaCl starts storing heat in the form of latent heat which can be used later. During night time the fibre glass is covered with doors of perfectly reflecting mirrors so that no heat will be radiated through the glass after sun set. Also the airgap will act as an insulator. The conduction pipe used is made up of copper and is insulated along the tower with a fire clay cavity, except within the chamber where it's supposed to conduct. A diagram showing the insulation of the copper pipe is shown below.

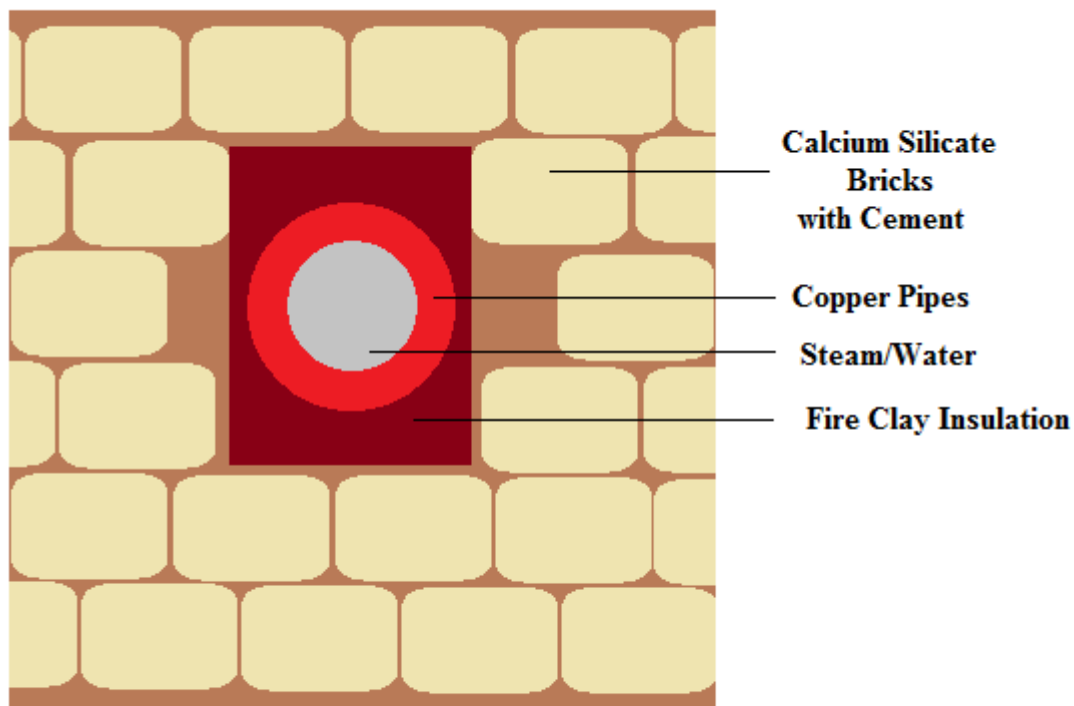

For a particular corner in the Salt Chamber the Airgap insulation is shown below. The Copper pipe in this section is free from the cavity to facilitate conduction for heat exchange.

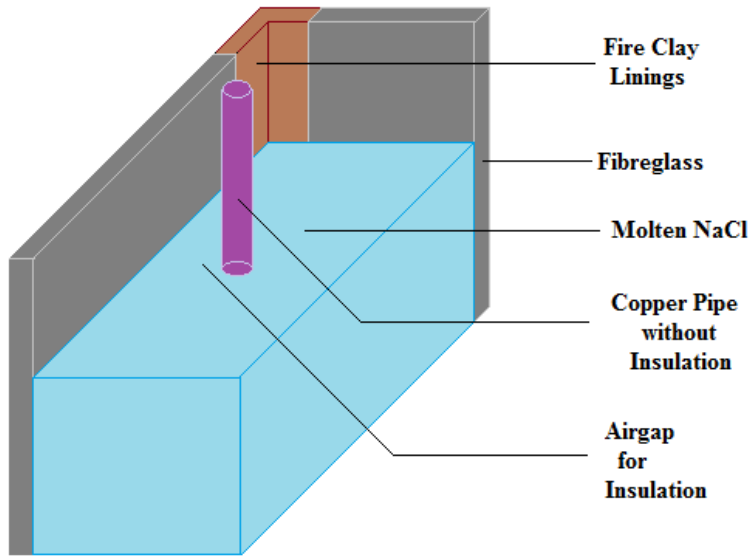

The inner surface of the wall is lined by Fire Clay Linings to resist the high temperature thus generated.

(d) CIRCULATING PIPES:

The circulating pipes are made up of copper because of their high melting point (1084°C). The pipes that are exposed to atmosphere can be covered with clay and sawdust mixture having a very good thermal resistivity (11.11 mK/w). The copper pipes carry the steam to the heat exchanger of the cooking vessel. The outlet water from the cooking vessel is carried through narrow pipes to the condenser.

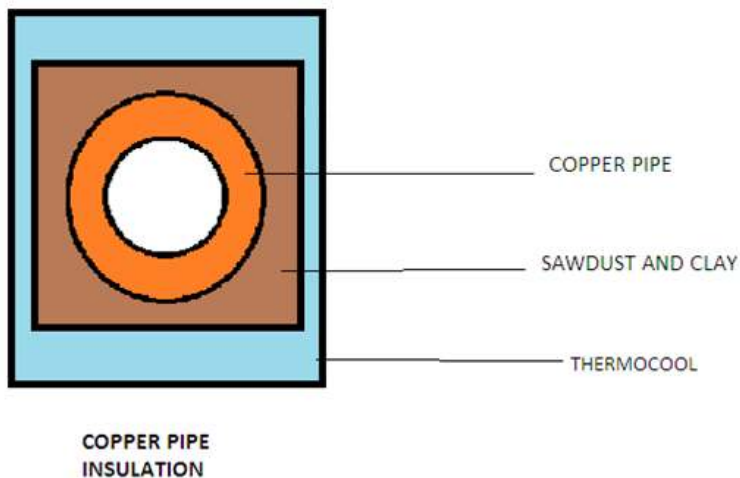

(e) COOKING UNIT:

The cooking unit is designed to cook various Indian foods .The design uses steam cooking mechanism. The steam comes from the solar thermal battery (pcm) through the copper pipe to the heat exchanger of the cooking vessel and supplies heat to the material to be cooked. Out of the two cooking vessel in the grill type cooking vessel the steam flows through the narrow grills and baking foods like chapatti and frying can be done.

*These grills have to be corrosion resistance apart from being good conductors. The possible options for the materials to be used in this are:

- Stainless steel (Usually the most expensive and longest-lasting option, may carry a lifetime warranty)
- Porcelain-coated cast iron (The next best option after stainless, usually thick and good for searing meat)
- Porcelain-coated steel (Will typically last as long as porcelain-coated cast iron, but not as good for searing)
- Cast Iron (More commonly used for charcoal grills, cast iron must be constantly covered with oil to protect it from rusting)
- Chrome-plated steel (Usually the least expensive and shortest-lasting material)

Considering requirement stainless steel or Porcelain-coated Cast iron Grills can be incorporated.

In the pot type cooker stainless steel vessel the heat exchanger is coiled around the vessel which exchange heat. This pot can also be made of earthen materials as used in traditional chulhas but in any case they have to be coated so as to reduce radiation losses. The inlet of the two cooking unit can be controlled by valve to regulate the supply to either of the two cooking unit. The outlet of the cooking unit is connected to a narrow pipe so that the outlet steam from the cooking vessel will be able to travel to the condenser placed just above the water tank. The junction of the two outlets is also guarded by a valve ensures the one way supply of steam.

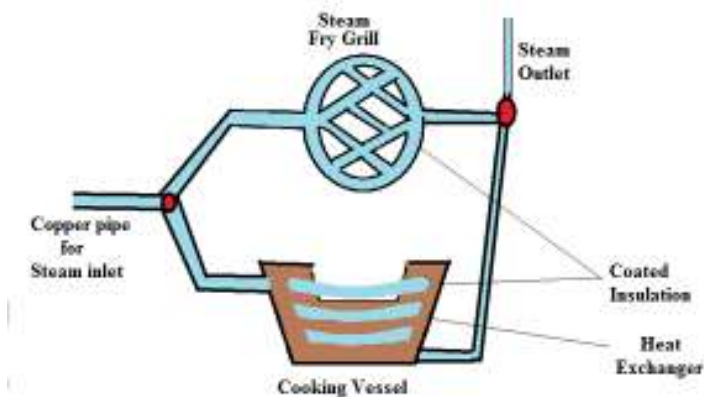

(F)CONDENSER :

The condenser is placed above the water tank to recycle the water. The steam coming from the outlet of the cooking vessel is transferred to the condenser and is allowed to expand and condense to water which is again supplied to the water tank.

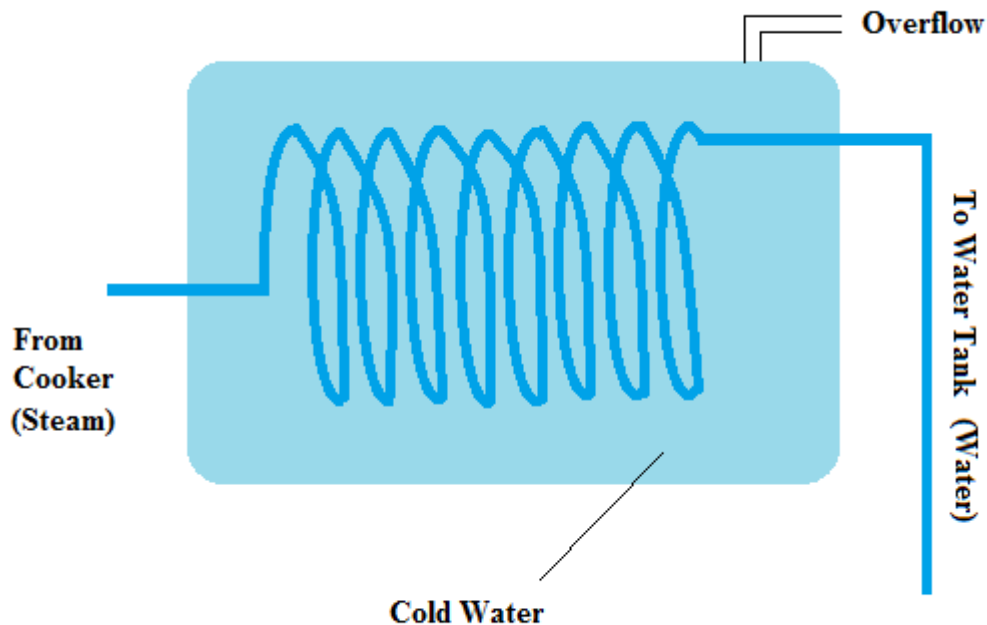

This tank is unpressurised and has an outlet for coolant overflow.

A daily maintenance of cold water is necessary from the part of the user. The volume of the condenser tank water should be sufficient to provide cooling throughout application time.

HOW IT WORKS:

The Step by step working of the Molten Solar Cooker can be shown from the schematic diagram below.

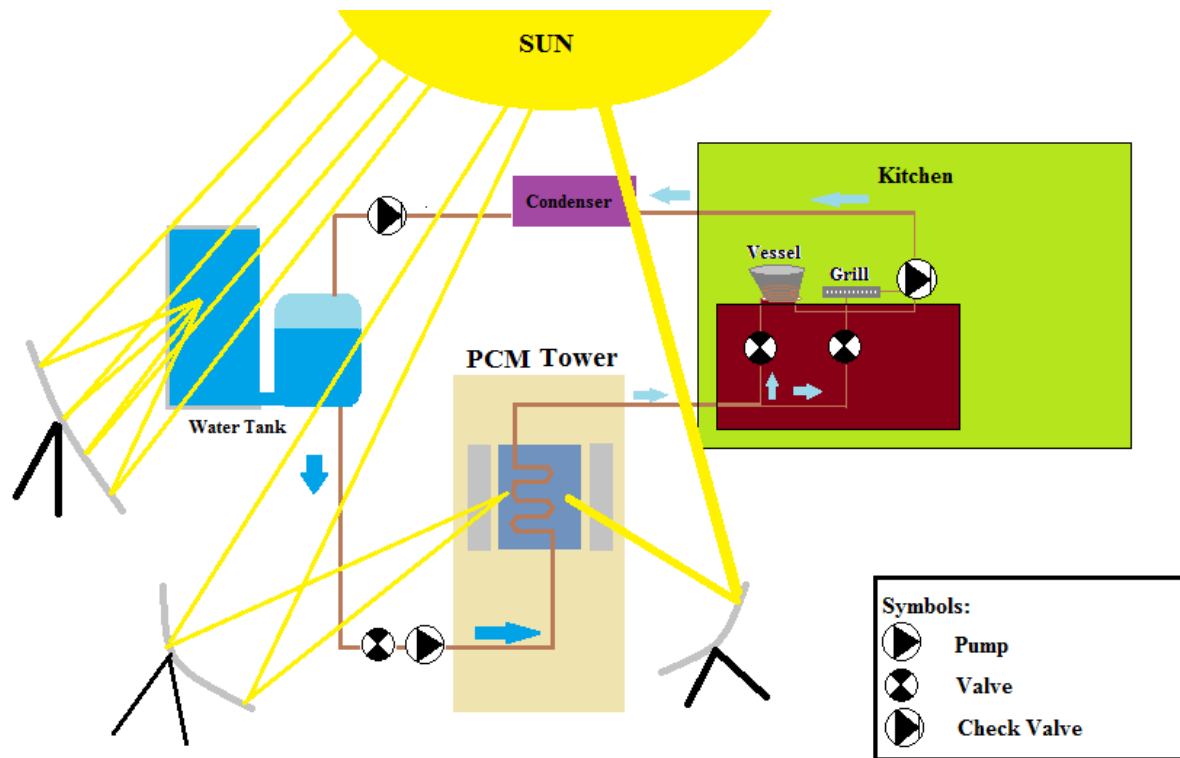

In the morning when the salt is not charged, the initial heat is generated by the Water tank. If the user wants to say boil water in the morning all he has to do is open the knobs of the valves that connect the PCM tower and the tank, and the one for the vessel. For frying a parallel arrangement of another valve is shown. However for cooking that requires greater amount of heat, the condenser valve needs to be opened which could be connected alongside the other Check Valve in the kitchen, for simultaneous opening. That is by opening the Check Valve in kitchen the user is also opening the condenser-Water Tank valve.

A check Valve makes the fluid to flow in only one direction as needed in the two points shown. During day time the NaCl start to charge itself thermally. Thus for speeding the cooking process the user can turn on the accelerating pump, for faster cooking. The Dark Blue arrow shows the direction of flow of water, while the light is for the steam. All the Valves must remain closed if no cooking is going on.

The Heat Energy for cooking in daytime is shared from the tank and the PCM.

In the night time, the Water Tank no longer is a source. The heat of the Molten Salt is to be used for night applications. Thus the Pump along with the other valves is opened and the heat

flows through convection. After cooking the Pump has to remove any residual water in PCM tower back to the Water tank and the Valves are again closed after cooking.

While passing through the heat exchanger the water gets converted to steam and passes to the heat exchanger of the cooking vessel through the insulated pipes. The heat from the steam is supplied to the food for cooking. Due to high temperature the steam remains in the form of steam and is passed through a narrow pipe above the level of the water tank. It is then passed through the condenser and the water is again supplied to the water tank. After sunset the PCM is covered by reflecting door from the outside so that heat loss through the glass can be minimized .At the time of cooking the water from the tank is regulated according to the requirement to get the desired amount of steam.

While passing through the heat exchanger the water gets converted to steam and passes to the heat exchanger of the cooking vessel through the insulated pipes. The heat from the steam is supplied to the food for cooking. Due to high temperature the steam remains in the form of steam and is passed through a narrow pipe above the level of the water tank. It is then passed through the condenser and the water is again supplied to the water tank. After sunset the PCM is covered by reflecting door from the outside so that heat loss through the glass can be minimized .At the time of cooking the water from the tank is regulated according to the requirement to get the desired amount of steam.

ADDITIONAL POSSIBILITIES:

- The regulation of water can be done inside the house to get the desired heat.
- The cooking unit may have some storing unit of steam for efficient cooking.
- If the steam has not sufficient kinetic energy to reach the condenser the water can be collected at the cooking vessel outlet and can be re-utilized.
- The outlet of the cooking vessel may be connected to a pump to circulate the water to the water tank in case if the rate of cooking is affected practically.
- The module of PCM can be mounted in the wall of the kitchen instead of a tower to reduce insulation problems.

CALCULATION:

Our requirement is to cook food for a family of 5 members during night time (two meals)

*The amount of heat required for cooking 2-meals can be calculated from the table below.

FIRST MEAL

SECOND MEAL

NAME	AMOUNT OF HEAT REQUIRED(kJ/°C)	NAME	AMOUNT OF HEAT REQUIRED(kJ/°C)
1KG Rice	1.8	750gm flour	1.38
250gm dal	0.368	250gm dal	0.368
65gm oil	0.1086	65gm oil	0.1068
125gm onion	0.468	125gm onion	0.468
250gm potato	0.8775	250gm vegetable	0.9
250gm carrot	0.9675	250gm potato	0.8775
TOTAL	4.221	TOTAL	3.701

TOTAL heat per unit temperature required for cooking two meals

$$=4.221+3.701 =7.923\text{kJ}/^{\circ}\text{C}.$$

Amount of water required for cooking assumed 6kg.

$$\text{Amount of heat required} =4.18 \times 6 =25.08\text{kJ}/^{\circ}\text{C}.$$

$$\text{Amount of heat required heat the pot} =0.92 \times 400\text{gm} =0.736\text{kJ}/^{\circ}\text{C}$$

$$\text{TOTAL HEAT REQUIRED}=(7.923+25.08+0.736) \times (120-25)=3205.68\text{kJ}$$

$$\text{Heat required in chemical reaction}=(170\text{kJ}/\text{kg}) \times 3.4\text{kg}=600\text{kJ}(\text{approx.})$$

$$\text{Latent heat of vaporization of water} =334.86\text{kJ}/\text{kg} \times 6=2009.1\text{kJ}$$

$$\text{TOTAL HEAT} =2009.1+600+3205.68=5814.485\text{kJ}$$

$$\text{OTHER LOSSE} =3\text{Mj}$$

$$\text{So heat required for cooking} =5.81\text{MJ} +3\text{MJ} =8.81\text{MJ}$$

Hence our per day cooking energy requirement is of 9-10MJ

CALCULATION FOR AMOUNT OF PCM REQUIRED:

Amount of heat required for cooking = 10MJ(approx.)

Latent of PCM (NaCl)= 492kj/kg

Amount of PCM required for supplying desired amount of heat

$$10000\text{kj} / (492\text{kj/kg}) = 20\text{kg}$$

CALCULATION FOR VOLUME OF NaCl:

The density of NaCl =2.165gm/cc.

Thus the volume needed= (20000/2.165) cc =9237.88 cc.

Taking into account the thermal expansion and airgap insulation needed for Molten Sodium Chloride we assume the Salt Chamber to be almost four times this volume= $9237.88 \times 4 = 369515.2\text{cc}$.

Thus by taking dimensions of 30x30x40 we get a chamber of volume 36000cc, as shown previously.

COMPARISON:

- The solar cooker will be able to cook food during day as well as night in comparison to other solar cooker which are only capable of cooking in sunshine hours.
- Unlike other cookers it provides indoor cooking,
- It is cost effective and the materials used are easily available and are durable.
- It doesn't produce any toxic gases and has no hazardous impact

CONCLUSION:

Within the given constraints, making a solar cooker that too with traditional means is no easy task. This design though may face greater practical difficulties when enacted but it will be robust enough in principle.

Even if it's not a complete solution to the problem of Energy efficiency but the design does add to this cause.

REFERENCES:

All information beginning with asterisks had the following links. Other links are also included.

*<http://solarcooking.org/>

* www.Solare-Bruecke.org for Datas on Scheffler Concentrators.

*www.wikipedia.com for Facts about cooking.

*www.fao.org for facts and calculations involving cooking.

*Solar Energy Textbook, S.D. Sharma.

*Development of asynchronous Powered Solar Cooker (2006),P. Femi Akinwale, MIT.

*www.ecs-solar.com

ACKNOWLEDGEMENT:

We are very grateful to our esteemed faculties of Electrical and Electronics Department who helped us for the design. Special regards to Asst. Prof. Seema Behera (faculty of renewable energy) whose inspiration and guidance has helped us to prepare the design. Special thanks to B. Ashish Kumar, batchmate who helped us.