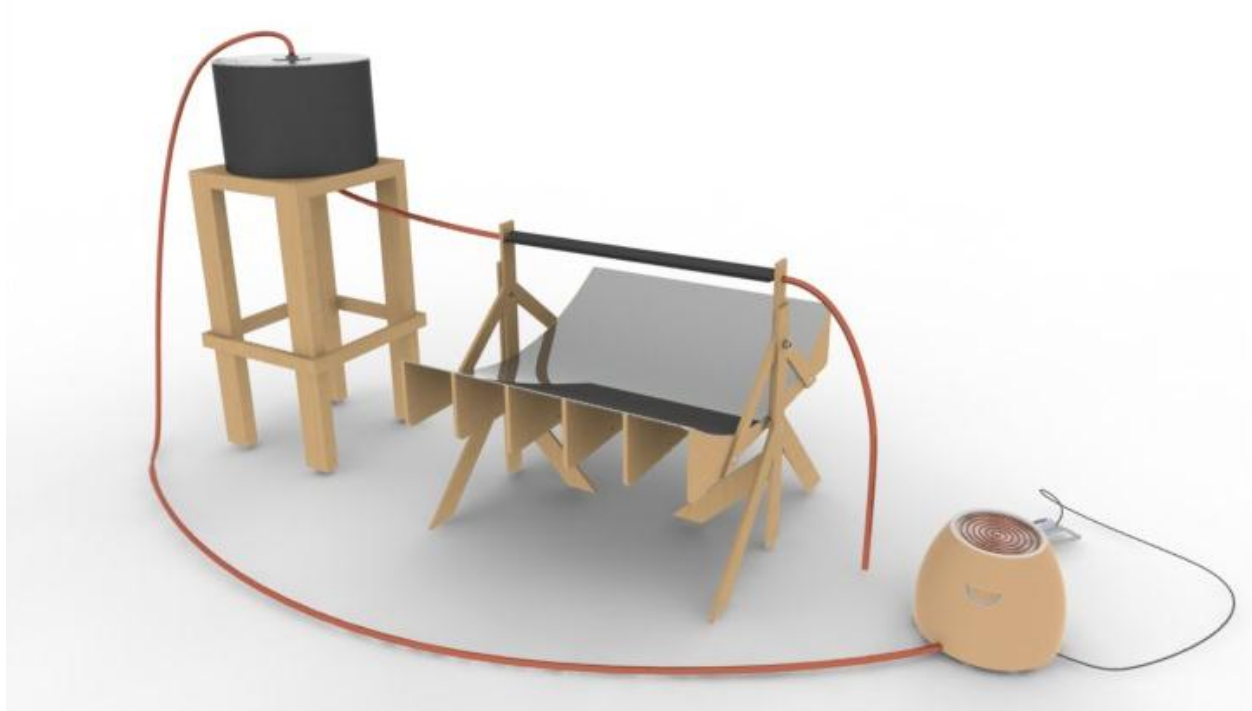


# SOLAR

The solar cook stove for North India

**Final Paper**  
**December 2, 2011**



Capstone Design Project with Climate Healers

Caitlin Chapin  
Jibril Leigh  
Phyllis Petronello  
Ivan Tivabinsky  
Ben Stewart

## I. Executive Summary

Climate Healer's presented a design challenge to solve the continual deforestation happening in rural India, specifically Rajasthan. The women in the villages within Rajasthan rely on wood burning stoves to cook for their families. The burden of collecting the wood is causing deforestation and is demanding on women collecting the wood. The smoke produced by the fires has led to increased reparatory problems among women and children. The challenge is to create a stove that will allow women to cook in the evenings and early mornings using solar power, in way that can be easily integrated into these women's lives. The design requires 4kW-hr of energy to produce up to 18 hours and for the system to cost less than \$200.00.

The solution presented is a system that uses olive oil as an energy storage device. The olive oil will be heated using a mirrored parabola and then stored in an insulated tank for later use. A manual pump will be attached to the tank and used to pump the stored hot oil into a heat exchanger which will act as a cooking element. The oil can then be continuously pumped through the piping of the system to extract energy for cooking until the user is finished.

A small scale prototype was created to test the efficiencies and feasibility of the design. A mathematical model was created to compare to the experiments. The collector when properly aligned efficiently heats the oil, however the storage tank's insulation is extensive to keep proper temperatures for cooking. The output design, with copper tubing, allows for rapid heat dissipation for cooking, as long as the flow rate is correct. The design fits the definition of appropriate technology and is designed for single families. It allows the women to sit down while cooking and cook inside, two important cultural cooking habits.

In Rajasthan, the design will cost a total of \$502. The cost of the unit is less important than if the unit is successful in replacing wood burning stoves. If implemented, the women of these rural villages will escape the health issues acquired from smoke inhalation while still working during the day. This appropriate technology will provide a sustainable solution for their fuel needs.

Overall, with further refinement, this system will provide a solution for replacing fire wood as the fuel source of rural Indian women.

## II. Table of Contents

I. Executive Summary.....	1
II. Table of Contents.....	3
III. Introduction.....	5
IV. Design Overview .....	7
V. Precedents .....	13
V.i Collector .....	13
V.ii Pump .....	15
V.iii Output .....	17
V.iv What's used now, what's been tried .....	19
VI. Value Proposition/Marketing Strategy .....	22
VII. Design details.....	27
VII.i Collection Subsystem.....	29
Collection: Mathematical Model .....	30
Collection: Testing .....	35
VII.ii Storage Subsystem .....	42
Storage: Mathematical Model .....	43
Storage: Testing .....	48
VII.iii Output Subsystem.....	51
Output: Testing Procedure.....	52
Output: Mathematical Model.....	55
Output: Experimental Results Analysis.....	57
VII.iv Human interactions .....	57
VIII. Sustainability Considerations .....	59
IX. Materials and Cost Evaluation .....	62
IX.i Energy Collection .....	62
IX.ii Energy Storage .....	66
IX.iii Cooktop.....	67
X. Realizations and Deployment .....	71

XI. Conclusion .....	75
XII. References .....	77
XIII. Appendices .....	84
A. Selection criteria tools (path) .....	84
B. Code .....	93
B.i Collection Code .....	93
B.ii Insulation Code.....	94
C. Additional System Images.....	95

### III. Introduction

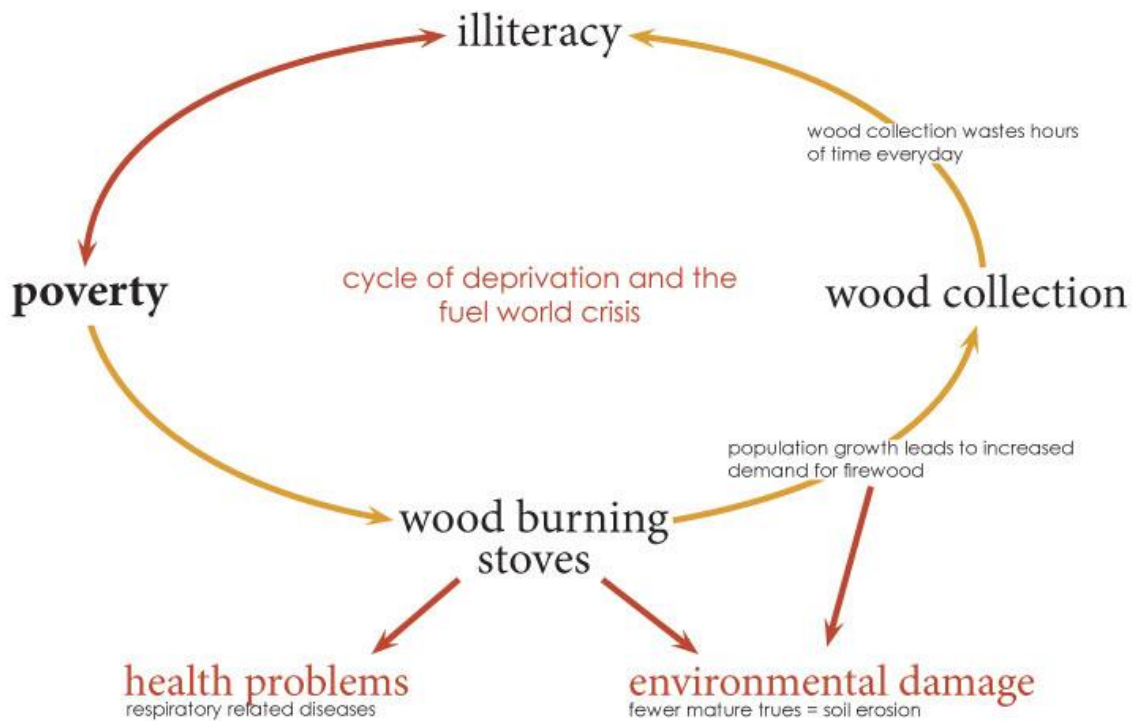
The rapid development of India and a growing population has led to natural resources and available energy for everyday use becoming sparse. Rural areas depend on the natural resources around them to support their families, both for sustenance provided by food and monetarily provided by agriculture. Additionally, many areas in rural India use wood as their main source of fuel for cooking. This demand has led to deforestation of the land, as well as increased health issues within the female population due to smoke inhalation during wood-fueled cooking [1]. Non-Governmental Organization's (NGO), including Climate Healers and Engineers for Change, have turned to alternative energies to provide for the energy needs throughout rural India.

The design sponsored by Climate Healers presented in this paper is specific to the area of Rajasthan, a rural and impoverished desert area of India. The monetary restrictions of the area have caused NGO's to turn to naturally occurring energy. For Rajasthan this project will focus on solar energy because Rajasthan receives an average of  $5.4\text{kWh/m}^2/\text{day}$  of solar energy in the form of solar radiation [2] and if harnessed could easily help solve the deforestation and health issues caused by wood burning cooking. From our initial cultural and background research the solar stove design direction involves three main functions, collecting solar energy, storing the energy and releasing the energy for cooking. Designs need to be appropriate technology for rural areas of Rajasthan as well as meet the specifications outlined within the paper both quantitatively and qualitatively. This paper will show the reader the design process of team SolAr through function definitions, design conceptualizations, testing and prototyping, as well as the information learned from these processes and how the team will continue from this point.

The cycle of poverty is the problem that will push the direction of the project. Figure III.1 graphically shows this cycle and how it affects the people in rural

India. Wood burning stoves are the most common form of cooking in rural villages, driven by the lack of money to afford alternatively fueled stoves. The use of wood creates smoke, which is unable to vent in the commonly found one room homes of villagers. This leads to health problems seen over time in women and children, not only from the smoke inhalation but also from the collection process. As the need to find firewood sends families further away from their homes, children are commonly inhibited from going to school so they can assist support their family. This lack of schooling continues the trend of illiteracy within the villages and can prevent families from escaping the cyclic nature of poverty.

By creating a product that is sustainable, a solar cook stove is able to solve more than just their fuel needs but also their illiteracy, health, and poverty woes as well. The goal of a successful solar stove is to increase the sustainability of Northern India, Rajasthan in particular, by changing and improving the life of the indigenous people and effectively encourage growth and development through forest restoration and empowerment of women.



**Figure III.1** The cycle of poverty in India

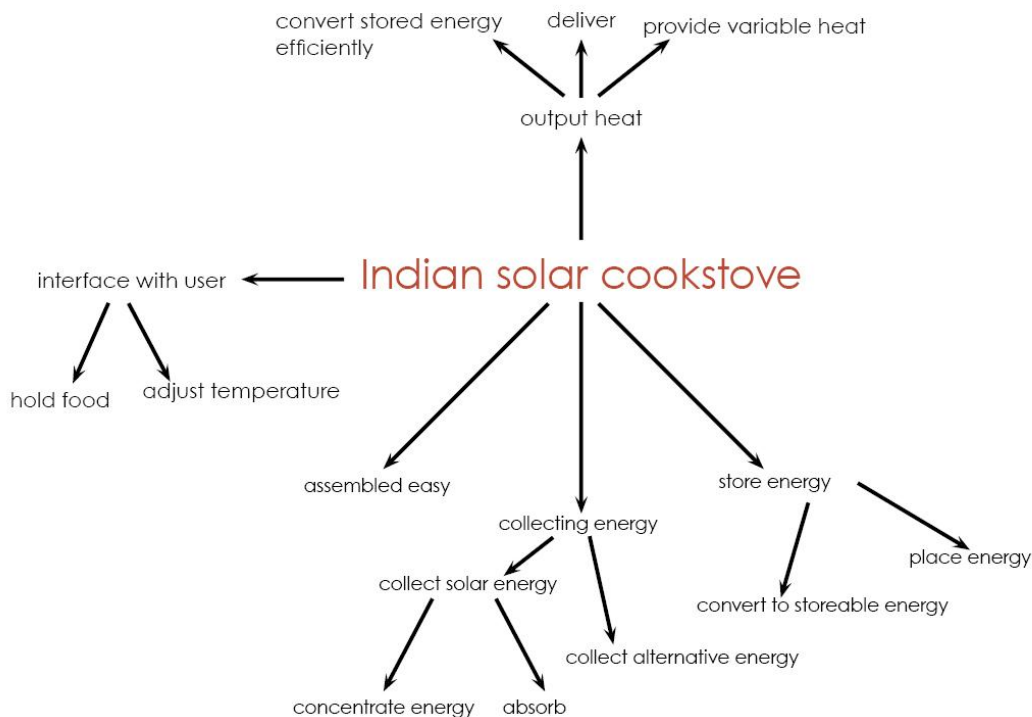
## IV. Design Overview

The goal of the system is to store energy that allows Indian women in rural Rajasthan to cook in the evening after the sun has gone down as well as in the morning before the sun comes up. Rajasthan receives, on average, 5.4 kWh/m<sup>2</sup> per day of insolation [2], one of the largest amounts across the globe, making solar energy the most abundant natural resource in the area.

A function tree, shown in Figure IV.1, was created to understand the system to be designed. There are five main functions, three engineering based and two that tackle the challenge of designing appropriate technology. Three of them have been closely analyzed as engineering functions; these include collect energy, store energy, and output heat. Two of the functions have been



discussed more in design terms; these include interfacing with the user and easy assembly.



**Figure IV.1** Function tree for Rajasthan cook stove

To begin the design creation and selection process it is important to understand the user needs for the design and the engineering demands for function in terms of the system. This is done using a House of Quality which leads to higher problem understanding. The House of Quality ranks user needs on a scale between one and ten, and then correlates the engineering requirements with the customer needs on a scale of one, three or nine, where nine is the strongest correlation. A House of Quality was created based on the customer needs in Rajasthan and is shown in Figure IV.2. This displays that the foremost important engineering requirement to meet is creating a system that is appropriate technology for rural India.

Customer Needs	Engineering Requirements									
	Importance	Solar Powered	Ergonomically Appropriate	Efficient Energy Storage	Low Material Cost	Efficient Solar Collector	Setup Ease	Fast energy output	Appropriate Technology	
Can cook in the evening and early morning	8			9		9			9	
No smoke/No use of firewood	10	9		3	3	3				
Inexpensive	6				5		1		3	
Simple construction	6		3				9		3	
Can Cook Roti Bread	9			3		3		9	3	
One per household	8				1		3		5	
Operable while sitting	9		9				3		5	
Cooking occurs with home	9		1		1		1	3	9	
Operable with children in arms	7		9						3	
Uses Local Materials	6	9	1		3				9	
Safety	10		3				1	9		
		18	26	15	13	15	18	21	49	
		144	198	129	86	129	121	171	295	1273
		0.113	0.156	0.101	0.068	0.101	0.095	0.134	0.232	

**Figure IV.2** House of quality to analyze customer needs

A specification sheet was created to outline the design numerically as well as help the decision process for designs. The values help select materials that are within design constraints so that they are not too expensive, too advanced of technology for Rajasthan and fits the ergonomic needs of the user. The left most column shows which specifications are designated as a Want (W) or a Demand (D) of the design. The specifications are then grouped by category such as geometry, energy and materials.

The system is to provide a cook stove that uses alternative energy, specifically solar energy, to eliminate wood stove cooking. The stove must be solar powered and retain 4kW-hr of energy for up to 18 hours. There must be no smoke emitted from the stove and it must not require the use of wood for usage.

The output of energy should release heat up to 200°C, a temperature determined by the villagers. This is the temperature which properly cooks the traditional choice of bread, roti. Maximum temperatures for the output were chosen based on safety concerns. Materials must be either shippable to Rajasthan or be found there, mostly found there so this is displayed as a want. They also must be able to withstand temperatures above 200°C to avoid failure, making these specifications a demand. Ergonomically, the women cook sitting down so the output must be within a height range of 1-2ft. Assembly, installation and maintenance depend highly on the design and must be cost efficient as well as performed by locals in the villages. Pieces that are possible to be constructed here and then shipped include the tanks and the outline shapes of the solar collector. This unit needs to last indefinitely, to avoid the conversion back to using wood for cooking. Geometry of various subsystems and forces associated with them are calculated and discussed in the subsystem break downs in the Design Details section. The initial cost requirement of the system was to be, in total, under \$200.00 however through our design process we believe that this value is unreasonable considering the desired specifications given by Climate Healers to create a solar powered stove. The design selection process is discussed further in Appendix A which includes morph charts as well as selection matrices for various parts of the system.

**Table VII.1** Specification Sheet

Changes	D/W	Requirements	Source
		Heats food to cooking temperatures	
		<b>Geometry</b>	
10/15/11	D	Operable while sitting by an Indian woman: Cooking unit 1-2ft off the ground	Climate H.
		<b>Force</b>	
	D	Be able to hold a pan with reasonable amounts	Team
		of food and water without failing	
	D	Easy to maneuver control system	Team
		<b>Energy</b>	
	W	Store 4Kwhr for 18 hours	Climate H.
	W	Temperature for cooking at least 200C	Climate H.
10/15/11	D	Minimize wood fuel use by at least half	Climate H.
10/10/11	D	Powered by Sunlight	Climate H.
		<b>Materials</b>	
10/20/11	D	Heated Fluid with $C_p > 1000\text{J/kgC}$	Team
11/18/11	D	Piping & Materials Operating Temp $> 200\text{C}$	Team
10/20/11	D	Boiling Point of Fluid $> 200\text{C}$	Team
		<b>Safety</b>	
	D	No Smoke	Team
	D	Failure by design	Team
11/20/2011	D	Temperature Maximum at Output of $230\text{C}$	Team
10/20/11	D	Visually simple working mechanisms	Team
	W	Color indicators for users to inform of temperature	Team
18-Nov	W	Ready to cook (heat up) in 10 Minutes	Team
11/18/2011	W	Cool down to room temperature(turn off cook top) within 20 Minutes	Team
		<b>Signals</b>	
11/18/2011	D	Clearly Visible/Defined On/Off Valve	Climate H.
	W	Warn the user about hazardous conditions: color indications	Team
		<b>Ergonomics</b>	
	D	Height of stove: 1-2ft	Climate H.
	W	Easily cleaned and maintained with readily	Team

Changes	D/W	Requirements	Source
		available household items for the area.	
		<b>Production</b>	
	D	Utilizes local materials such as wood, sand and clay.	Climate H./Instructors
	D	Made locally	Climate H./Instructors
		<b>Maintenance</b>	
	D	Locally available repair and maintenance services using only standard screwdrivers and wrenches.	Climate H./Instructors
		<b>Assembly</b>	
11/18/2011	D	Only standard screw drivers and wrenches needed	Team
	W	Requires a maximum of 3 people for assembly	Team
	W	Literacy is not required	Team
		<b>Quality</b>	
	W	Visual inspection only	Team
11/18/2011	W	Collector Alignment performed with Laser Pointer	Team
		Cost	
	W	<200\$	Climate H.

To accommodate these functions, the following system has been designed for the collector. A parabolic collector will be used to concentrate solar energy into a pipe containing oil. The oil will flow through the pipe due to gravity. The flow rate has been chosen such that oil will reach an optimal temperature for the average solar insolation flux for the day. After the oil is heated, it will flow into a tank buried underground. The sand that the tank is buried in will serve as insulation. When the user is ready to cook, she will pump oil up into narrow spiraled copper tube which will serve as a cook top. The stove has been designed to be an open system, so after cooking the oil drops into a reservoir. At the end of the cooking process, the oil will need to be placed back

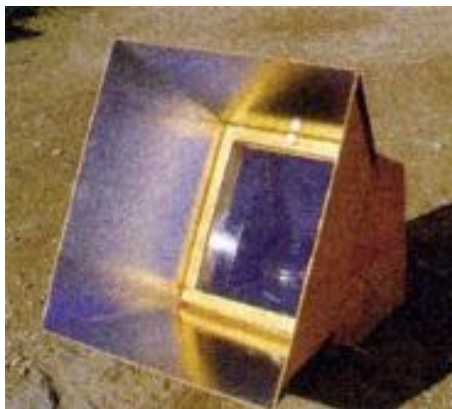
into the cold oil reservoir tank to be used the next day. A brief precedent study and the design selection process are below in Section V and VII.

## V. Precedents

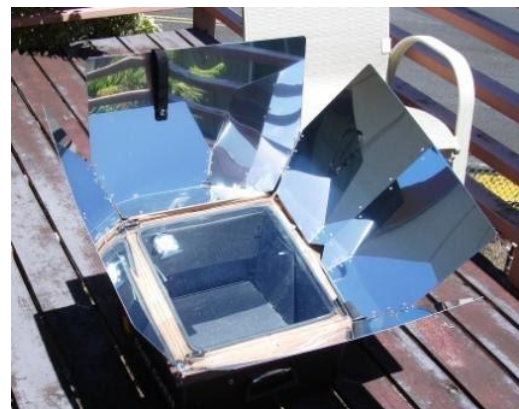
Research into precedents for the system was performed before the system was designed. In the next subsections, an overview of the major research done is described.

### V.i Collector

The idea of an oven that uses solar energy to cook with is not a new idea. Many different types of solar cookers have been made before this project. These solar cookers can be divided into several broad categories including panel, box and parabola cookers. A panel solar cooker usually consists of several flat panels that are placed around the object that is heated. This design is simple and provides a cheap setup for the user by aiming reflective panels at a central point to allow for heating of an object, pot, or pan. A box solar cooker design generally uses similar reflective panels that focus sunlight into a black lined storage box covered on the top with a glass window. Figures V.i.1 and V.i.2 exemplify a box collector.



**Figure V.i.1** The 30°/60° box solar cooker[3]



**Figure V.i.2** The Sun Oven [4]

The black lining absorbs heat and the glass cover allows the greenhouse effect to occur, leading to the heating of a desired object. Usually several pots can be heated at the same time at medium to high temperatures. Finally, the parabolic solar cooker design, shown in Figures V.i.3-5, uses concave reflective surfaces to concentrate sunlight at a converging point where a pot or pan can be placed. This design allows for quick cooking at high temperatures. Power efficiency, the amount of sun radiation that hits the surface compared to the energy collected by the heated item, of over 50% has been reported. There are many variations on the above general solar oven designs. In the following section, several of them will be explored. [5-17]



**Figure V.i.3** The Auroville solar collector [18]



**Figure V.i.4** Scheffeler solar community collector [19]



**Figure V.i.5** Parabolic basket and tin can solar cooker [20]

## V.ii Pump

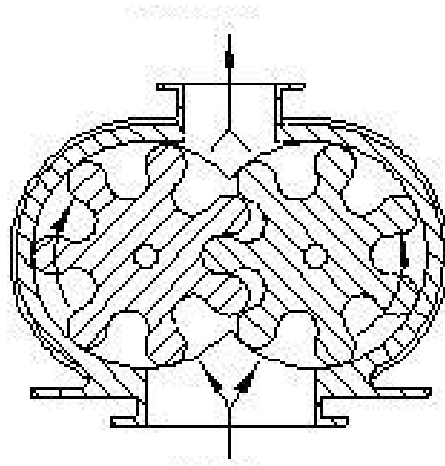
One of the important components in this project will be a hand or foot pump, since the energy transfer to the heating element will be provided by moving a hot fluid as discussed below in Section VII.iii. There are many existing pumps that are already on the market that would work in this design. These pump types include piston pumps, diaphragm pumps, rotary pumps, and piston pumps. Diaphragm pumps are pretty simple. Fluid is pushed through a pipe by shrinking the volume of the diaphragm, which is usually done by squeezing the flexible bulb. However, when the diaphragm expands, a one valve prevents the fluid from flowing in the other direction[21]. A diaphragm pump are shown in Figure V.ii.1.



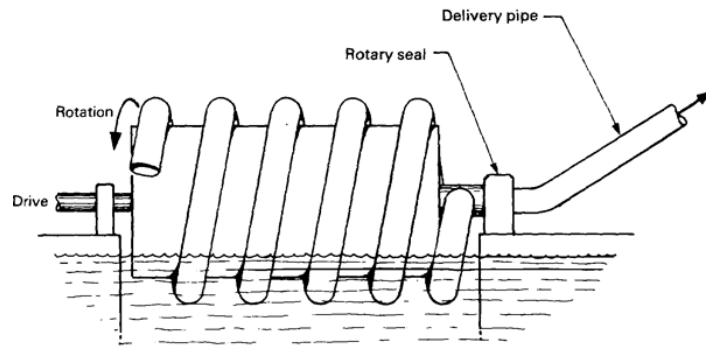


**Figure V.ii.1** Hand operated diaphragm pump [22, 23]

A rotary pump, similar to a screw pump, uses rotational motion to push the fluid through the pump [24]. A rotary pump and a screw pump is shown in Figures V.ii.2 and V.ii.3, respectively.

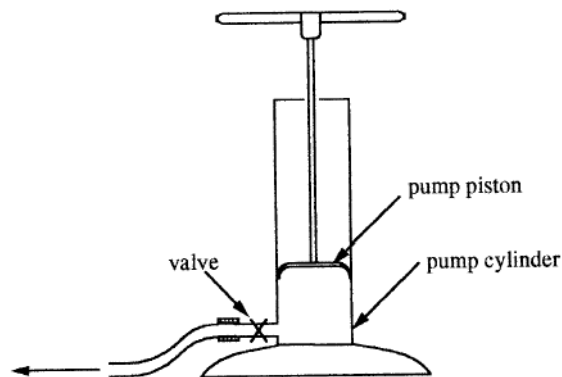


**Figure V.ii.2** Schematic of example of rotary pump [25]



**Figure V.ii.3** Schematic of example of screw pump [26]

Common pumps people use on a daily basis are bicycle pumps, Figure V.ii.4. These are simple pumps that use pressure that is applied by piston. Again a one valve is used such that the fluid does not escape when the piston is lifted.



**Figure V.ii.4** Bicycle pump diagram [27]

### V.iii Output

The current method for cooking meals in most Rajasthani homes involves the traditional three-stone cooking fire. The three-stone cooking fire is built from three stones of equal height so that a pan may be placed on top of it for cooking. While this is certainly the most cost effective stove to produce, there

are several major flaws associated with it. The fire occurs in the open and loses a great deal of energy to the environment. As a result of this inefficiency, the user must burn even more wood. Accumulating this wood leads to quicker deforestation of the surrounding areas, increased air pollution, and requires more time spent collecting wood. The lack of venting of the stove leads to increased risk for smoke-induced health problems. The stove can only cook one pot at a time. The open fire puts the family at risk of burns and fires. Figure V.iii.1 shows a woman using the three stone fire. [28]



**Figure V.iii.1** Indian women cooking on three stone fire

An improved version of the Chulha, a traditional clay stove popular in India, was recently developed by the Philips design team. This redesign greatly increased the efficiency of the stove and addressed the health issues associated with woodburning stoves. The stove featured a chimney for smoke and the ability to adjust the temperature via dampers on front of the stove. The stove was found to be up to 40% more efficient than the traditional Chulha that it was replacing. The convenience of this stove made it very popular among the villages where it was implemented. [28]. Even though the stove's chimneys allow

for the redirection of smoke emissions, the stove still relies on the use of wood for cooking fuel. The goal is to eliminate the use of this biomass and use an alternative energy that is more sustainable and does not emit any smoke, preventing any chance of respiratory problems for the women who cook.

#### **V.iv What's used now, what's been tried**

Climate Healers collected a team of engineers to build a solar cooker to help the local environment and stop deforestation. The solar stove first implemented is called the Namaste cooker, shown in Figure V.iv.1 [29]. It consists of 2 large parabola shaped panel mirrors that are pointed towards a converging point between the two. At this point a stand is placed that holds a pot or pan that is desired to be heated for cooking. The setup was simple, however it had many faults. It was unable to store heat for later use and could only be used between the hours of 10AM and 4PM, peak sun hours, when the villagers were mostly at work. It also takes longer to cook food using this solar cooker than cooking with firewood. It also forced the families to cook outside and standing, which is unconventional for the culture. Lastly it needed constant adjustment to make sure that the parabolas were receiving and concentrating as much energy from the sun as possible. These were the main reasons that Climate Healers turned to outside sources for help in design of a new solar cook stove. At this point The University of Iowa and Berkley started their own designs.



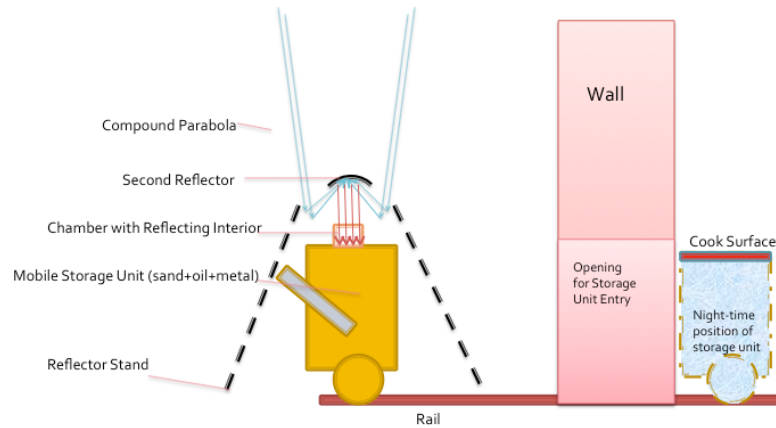
**Figure V.iv.1:** Namaste Solar Cooker

Berkley built the Namaste stove and tried to alter it by adding a thermal energy storing unit to the system [30]. Their final design consisted of an evacuated tube with a heat pipe inside of it, for collection, with a parabolic reflector behind it to concentrate the sun's rays towards said tube. Connected to the tube was a storage tank and using heat exchangers would convert the thermal energy and allow the user to access boiling water and heat at will. The Blazing Tube collector is shown in Figure V.iv.2. The Berkley team created a working prototype but it was over \$1,400 and only stored 1kW-hr of energy.

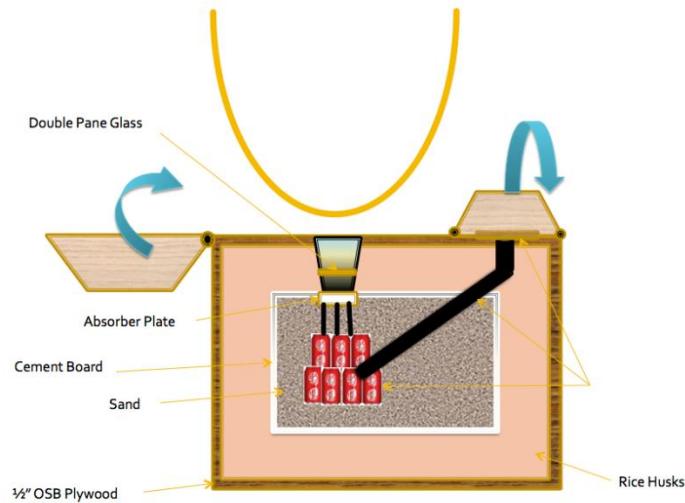


**Figure V.iv.2:** Berkley's Blazing Tube solar collector

The University of Iowa had also created a solar cooker parallel in time to the Berkley students [31]. Iowa turned to Berkley for reference however, it took a different design approach for collection and storage. A collector plate was placed at the bottom of concentrated reflective surfaces and energy was funneled into an insulated box with sand (insulation was rice husks from around the village) and stored there until necessary to release. The Iowa team was able to build a prototype; however, it fell short of the design requirements set out at the beginning of the project. Breakdowns of the Iowa collector and storage units are shown in Figure V.iv.3 and Figure V.iv.4.



**Figure V.iv.3:** Iowa Design Side View



**Figure V.iv.4:** Iowa Design Interior View[31]

## VI. Value Proposition/Marketing Strategy

Currently, women in rural north-west India require wood burning fires for cooking. In Rajasthan, 99% of families depend on biomass for their source of fuel and for 87% of those households the biomass they depend on is wood [1]. This dependency drains time out of the Indian women's day because they tend to be the primary care givers and providers in the house hold. Women walk about 2.5 miles one way and make about 16 trips a month to collect wood. This takes approximately 50 hours a week [1]. Not only is the dependency on wood time

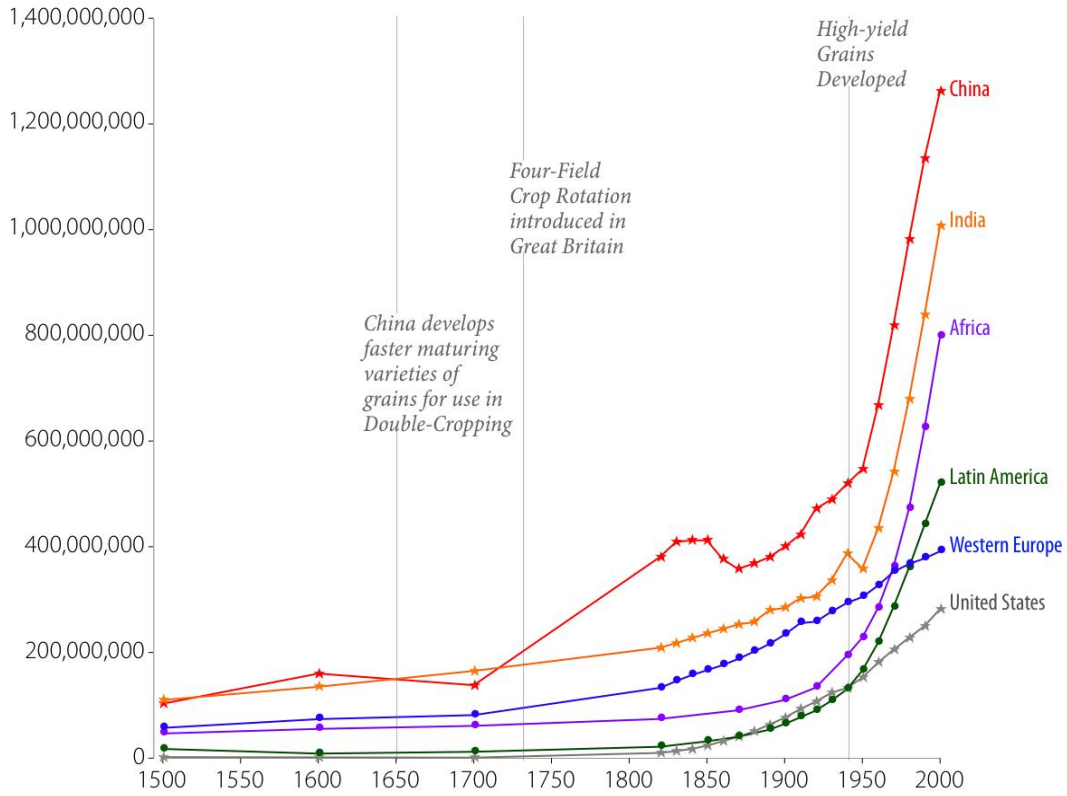
consuming but burning wood for cooking also effects the women's health. The homes in rural Rajasthan are predominantly one room houses [32]. Cooking is predominantly done inside because culturally Indian's do not want other families to be aware of their financial status, which can be seen based on the amount of food being cooked. Therefore, smoke inhalation is a major problem since there is not much if any ventilation in the homes. The *Collection of Wood Studies* indicates that exposure to biomass smoke or indoor air pollution (IAP) is associated with chronic bronchitis, tuberculosis, cataracts and acute respiratory infection (ARI)[1, 33].

In addition to being a burden on the people of Rajasthan, wood collection for cooking is also a burden on the environment. India has one of the fastest growing populations in the world and is the second most populous countries in the world as seen in Figure VI.1. The current population is 1.16 billion people, making up 17.5% [34] of the world's population. Despite its large population, India only contains 1.7 % of the world's forest coverage [34]. Wood is not only used for cooking and heating, it is also needed for the development and advancement of industry. Comparing another rural town in Northwestern India, only 4% of forest cut down in rural Northern India is used for industry development, [35] showing that the majority is being used domestically. The forest cover itself stayed constant after 2000; however the other wooded cover in India had declined drastically. Wood cover is the category villagers extract their cooking fuel from. In 2010, the number of hectares of this type of wooded cover in India was recorded as 3267000 hectares [36], a large decline from the level in 2005 recorded as 4110000 hectares, shown in Figure VI.2. This is a 20% decrease in this type of wooded cover in overall India. Population increase and deforestation is then seen to be a cyclic issue that needs an alternative solution to break.



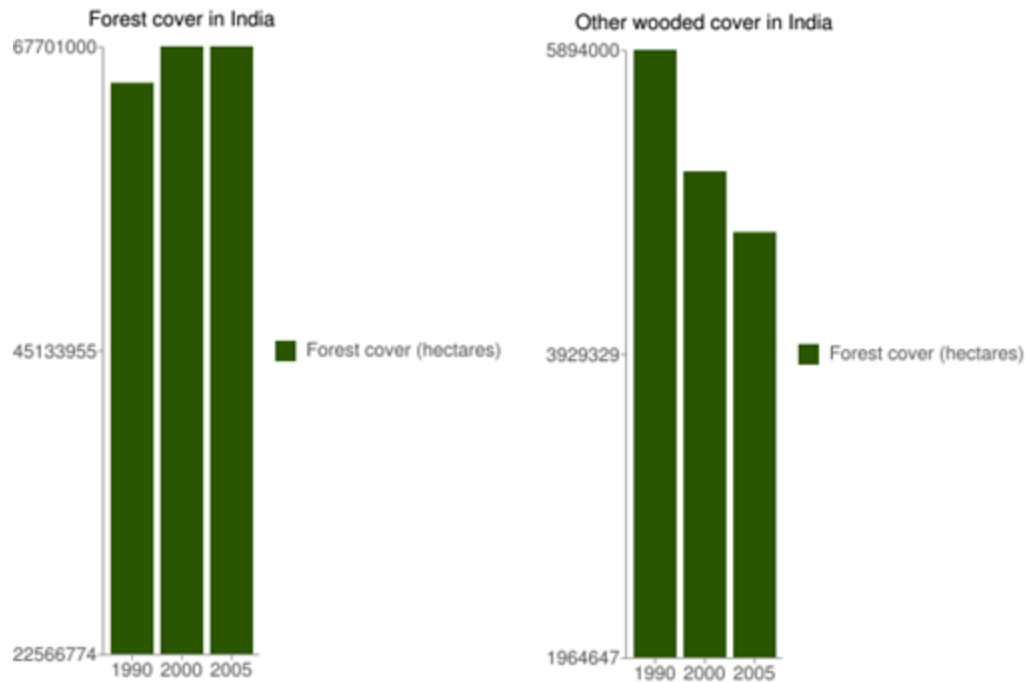
### Population Growth over the Last 500 Years

China, India, Africa, Latin America, Western Europe, and United States



Source: Angus Maddison, University of Groningen

Figure VI.1: Population Growth in India [34].



**Figure VI.2.** Deforestation Data in India [36]

Due to the effect that wood burning has on both the communities and the environment, there is a need for a new energy source to cook with. However, in order for this system to be implemented in the communities of Rajasthan a marketing strategy is needed to sell the product. This value proposition will address key elements in order to understand what is needed for adoptions including: user motivation, affordability, and ease of use.

The first and most important determinant of adoption of a new technology is inherent motivation. For the SolAr solar cooker, this is connected with the perceived value of the collector. In rural areas, where fuel wood is free, users will not initially be motivated to purchase stoves.

One of the best ways to overcome this will be to further educate the people on the benefits of moving away from wood burning as a source of energy. Many girls get pulled out of school to help their mothers with chores, especially collection wood. If the stove was implemented, children, especially girls, would not need to be pulled out of school to collect wood. This would

provide opportunities down the line for these children to break the cycle of poverty (shown in Figure III.1). This is a major motivating factor for parents to adopt a new system for cooking.

Another motivation for adopting this system is that available medical care in rural Rajasthan is poor quality. According to a survey done in Udaipur, Rajasthan, many local health centers were staffed only by one nurse. Additionally, the local health care center were closed 56% of the time during opening hours, and only 12% of these closed periods were the nurse attending to a patient [37]. The average distance from to a health care facility was found to be 1.4 miles in Udaipur, about an hour and half walk. However, since the health centers are open sporadically and infrequently it is a gamble if one would be able to receive medical care [37]. Additionally, families reported spending about 7.35% of their income on health care. Thus, seeing a nurse is both time consuming and expensive [37]. IAP is detrimental to health, causing chronic bronchitis, tuberculosis, cataracts and acute respiratory in the women using wood burning stoves. Thus, educating the population about the benefits of moving away from cooking with fires would be an effective marketing tool.

Once household are motivated, other barriers still remain, including making the system affordable. People living on less than US\$1 to \$2 per day, like most in rural Rajasthan will not be able to afford a stove even with financing [38]. In such cases, subsidies are necessary. There are several subsidies from the Indian government that could help fund the construction of this system. One of these programs is called the Swarnajayanti Gram Swarajgar Yojna (SGSY ) [39]. Under the SGSY the government funds the rural poor to organize self-help groups, to build infrastructure, and to provide need technology, among several other things [39]. The SolAr system fits into all three of these categories. With the help of Climate Healers, the villagers of Mewar and other villages in Rajasthan could apply for this subsidy to help afford the system. The SGSY is aimed at helping rural areas by providing with the means of social mobilization [39].

Other Indian subsidies that may provide help fund this system include the Jawahar Gram Samridhhi Yojna, and the District Rural Development Agency scheme [40]. Additionally, state and local subsidies exist.

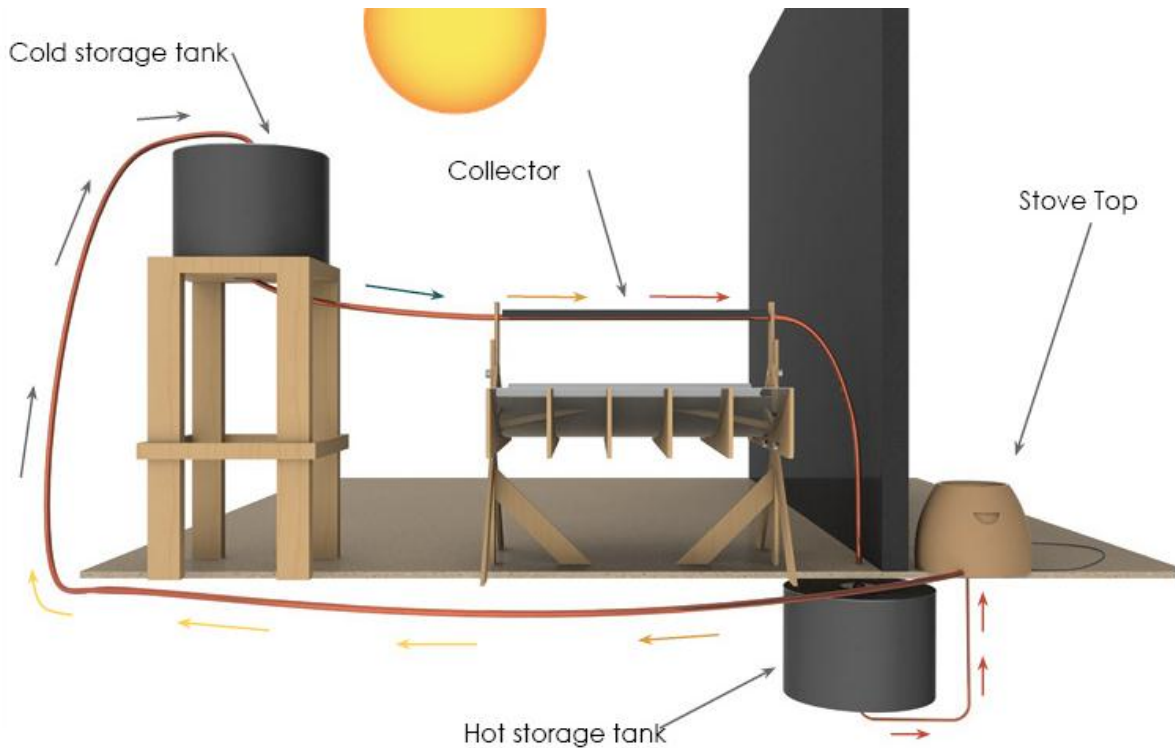
Climate Healers has also proved willing to help fund initiatives in rural Rajasthan to help eliminate deforestation. In the past, villagers in Mewar were paid by Climate Healers use solar flash lights rather than kerosene or fire for light. Salish Rao is also enthusiastic to support a solar cooker that does not require the use of wood which gives off carbon emissions. Mr. Rao would be willing to help fund or subsidize the cooker. Thus, there are several scenarios, government or private funding that would make the system affordable to Rajasthanis.

A final barrier to adoption of a new technology is providing a system appropriate to the area. System interaction, lifestyle adjustment and the size of the system will all effect how the people react to the system. This system is designed such that it is possible for the locals to understand the principle sciences of the science and the basic construction of the system. Detailed instructions of construction, use, and maintenance will need to be provided to the locals. However, once the education process for the system is over, it should prove to be within the capabilities of the locals to use and maintain this system. Indians are willing to make changes, in fact they are eager to improve their quality of life. Thus, with the right education about the systems and its benefits and subsidies, the Rajastani's will be motivated to adopt this system

## VII. Design details

The present design consists of three activities- collection, storage, and output, which are depicted in Figure VII.1. In the first subsystem, a solar collector is used to concentrate solar energy into a moving fluid. The fluid chosen for the design is olive oil because it has a high specific heat to cost ratio; this will be discussed further in section IX. The oil is moved via gravity. This will also be

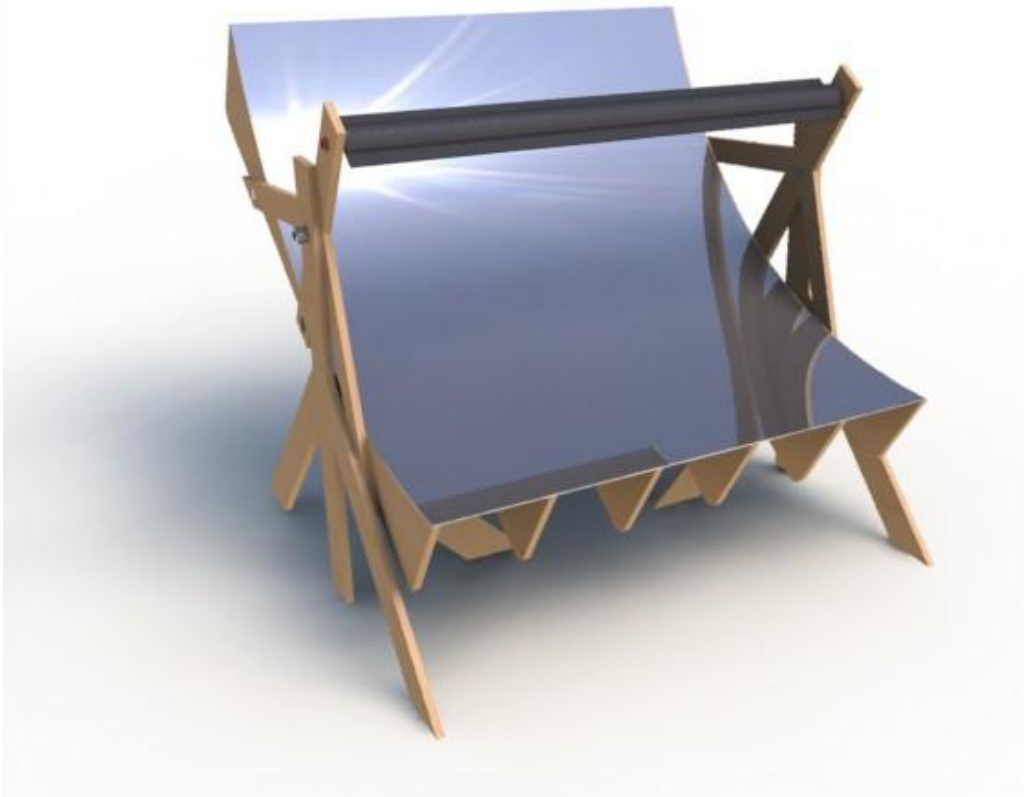
discussed in section VII.ii. This fluid is heated to its highest temperature based on several variables including flow rate, area of the collector, emissivity, absorptivity, reflectivity and boiling/smoking temperatures, among others. The possible temperature the oil can reach was model, which is presented in section VII.ii. Then, the fluid goes down into a storage tank, which is buried underground and keeps the fluid hot. The ground serves as insulation; a model was created for this subsystem, and is described in section VII.iii. Finally, pressure is applied to the hot fluid and it flows to the dissipating coils, which heat up the cooking surface. Bernoulli's equations were used to determine the pressure needed to move the fluid, section VII.iv. Additionally, testing of a scaled collector and heating element has been done, shown in section VII.ii and VII.iii.



**Figure VII.1.** Depiction of the entire system

## VII.i Collection Subsystem

The collection subsystem consists of two parts: two oil reservoir tanks and the solar collector that is used to heat the oil. The cold oil tank reservoir is supported by a wooden stand above the collector to utilize gravity-driven fluid flow through the pipes. Piping directs the oil to flow into the collector and become heated, after which it flows outward into a hot oil reservoir tank for storage for a later time. This motion for heating is controlled by a brass valve that determines the flow rate of the fluid for the day. On colder days the valve will need to be closed more, and on hotter days the fluid flow will need to be faster. An appropriate flow is needed to keep the temperature of the oil under its smoke temperature, as well as to ensure that the materials used in the design to not exceed maximum temperature applications.



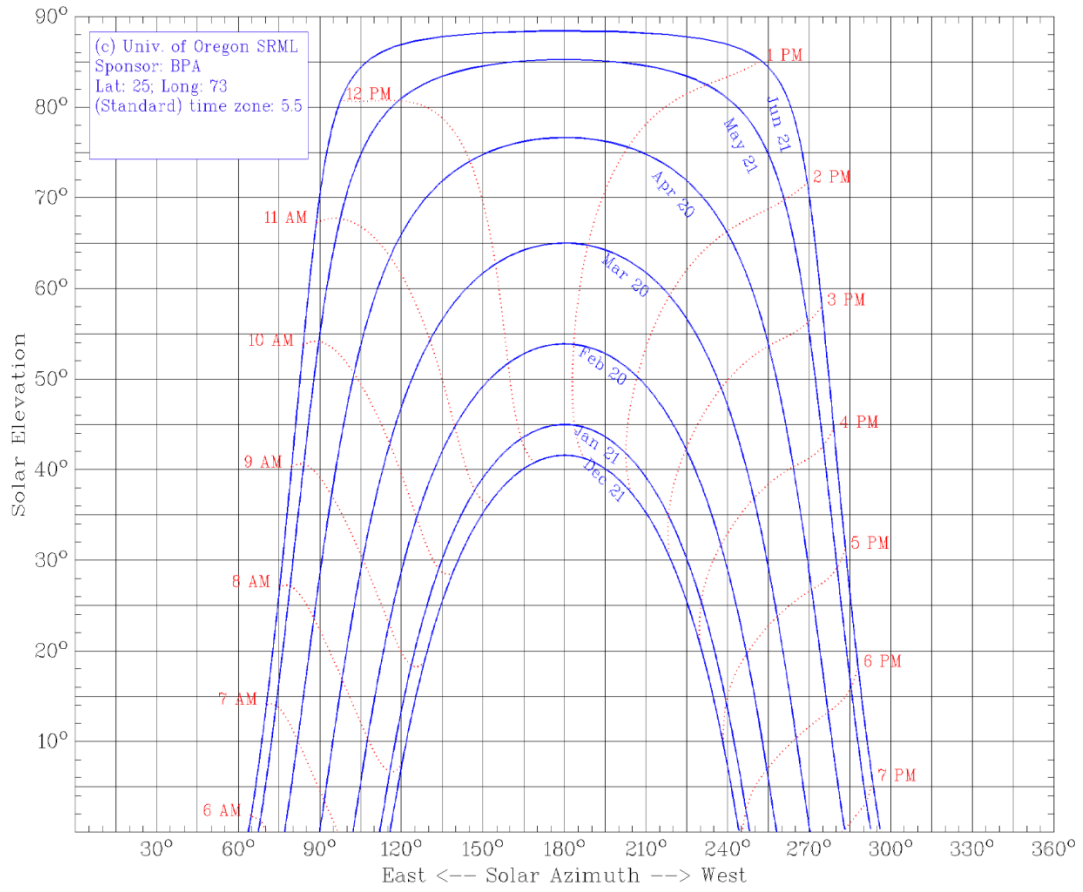
**Figure VII.i.1** The schematic of the solar collection subsystem.

## Collection: Mathematical Model

---

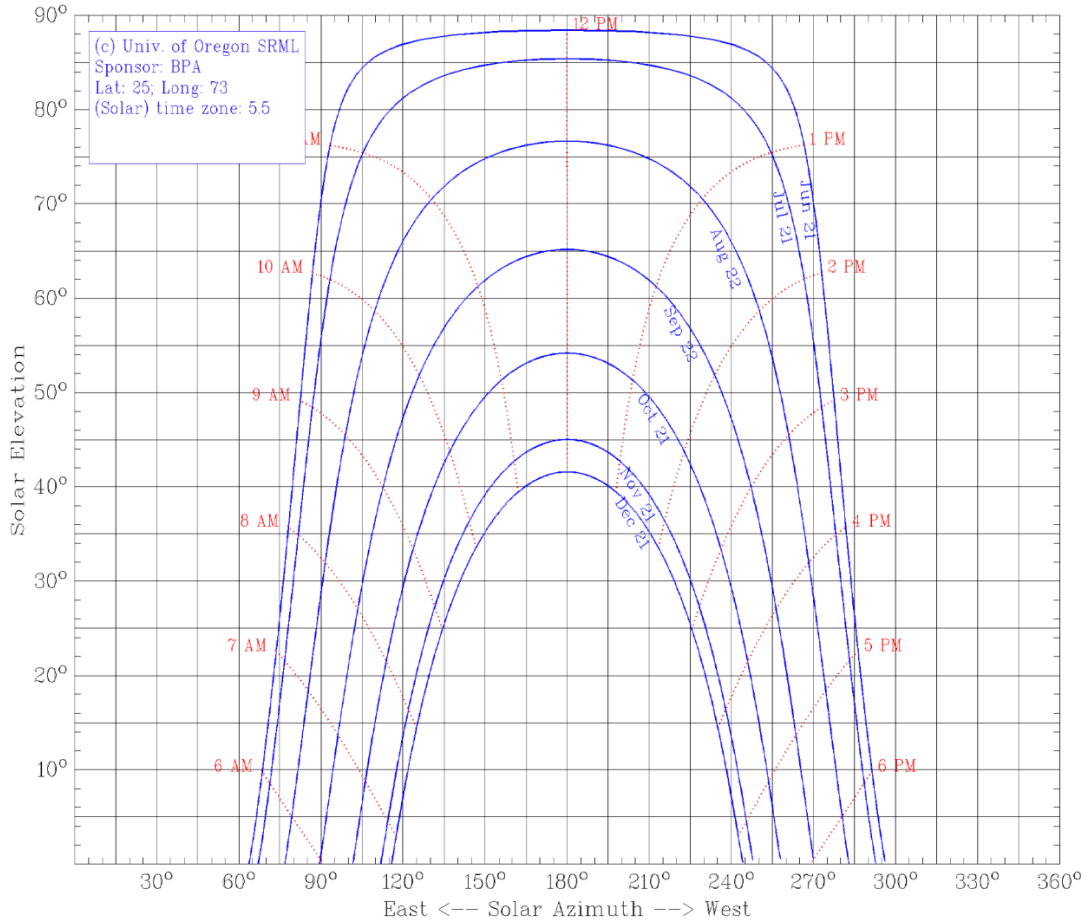
Solar energy is collected using a parabolic reflective trough. It is oriented at an angle towards the equator equal to the latitude of the place where it will be used. This calculation is only appropriate for a certain time of day. As the sun moves throughout the day and the height of the sun changes, the pitch of the collector must be changed to allow for maximum heating of the oil [41].

The optimal angle of the collector changes as a function of the time of day, this angle is also called the Zenith angle [42]. This not only fluctuates based on time of day, but also on time of the year. The other angle involved in positioning the solar collector is the Azimuth angle [42], which is the angle the sun is from north at a given time. Two charts have been made for Rajasthan, India, shown in Figure VII.i.2 and Figure VII.i.3, that show the different angles for various months and times as an example of the changes within the region of implementation of the solar stove [43]. To find the Zenith angle, the angle at which the solar collector should be positioned at, is found by taking  $90^\circ$  and subtracting the solar angle, found on the charts.



**Figure VII.ii.2:** Zenith and Azimuth angles for June-December





**Figure VII.i.3:** Zenith and Azimuth angles for December-June

Now that the angles for maximum collection at each time of day during the year are known, the heating of the fluid within the collector tube can be analyzed assuming these angles. The amount of heat collected in the working fluid can be calculated with the expression below [44], Equation VII.i.1

$$q_{\text{rad,in}} = \rho \alpha I A_{\text{col}} \quad (\text{VII.i.1})$$

where  $\alpha$  is the absorptivity of the container and working fluid together,  $I$  is the insolation,  $\rho$  is the efficiency of the collector, and  $A_{\text{col}}$  is its footprint area.

The analysis has been performed on a yearly average. To obtain the insolation value per unit area of the collector, the average insolation per meter

squared of Rajasthan was divided by 12, the number of hours of sunlight on average per year.

The heated oil also loses heat by radiation outward into the air at the rate given by Equation VII.i.2

$$q_{\text{rad,out}} = A_{\text{cont}}\varepsilon\sigma T_{\text{cont}}^4 \quad (\text{VII.i.2})$$

where  $A_{\text{cont}}$  is the surface area of the cylindrical container holding the oil,  $\varepsilon$  is the emissivity of the material of the container, and  $T_{\text{cont}}$  is the temperature of the fluid and its container [44]. This scenario is a lower bound for efficiency, because some of the radiation from the fluid and its container would be reflected back to the fluid due to the collector. Also a material with a low emissivity can be used to cover the side of the container that does not face the collector to prevent radiation losses.

Also to obtain conservative results, convection losses from the fluid and container were taken into account. The amount of heat transfer is shown in Equation VII.i.3

$$q_{\text{conv}} = A_{\text{cont}}h(T_{\text{cont}} - T_{\text{amb}}) \quad (\text{VII.i.3})$$

where  $h$  is the convective heat transfer coefficient [44] calculated internally with the modeling software Engineering Equation Solver given the ambient temperature,  $T_{\text{amb}}$ , the temperature of the fluid and its container, the ambient pressure, average wind speed, and the geometrical information of the working fluid container.

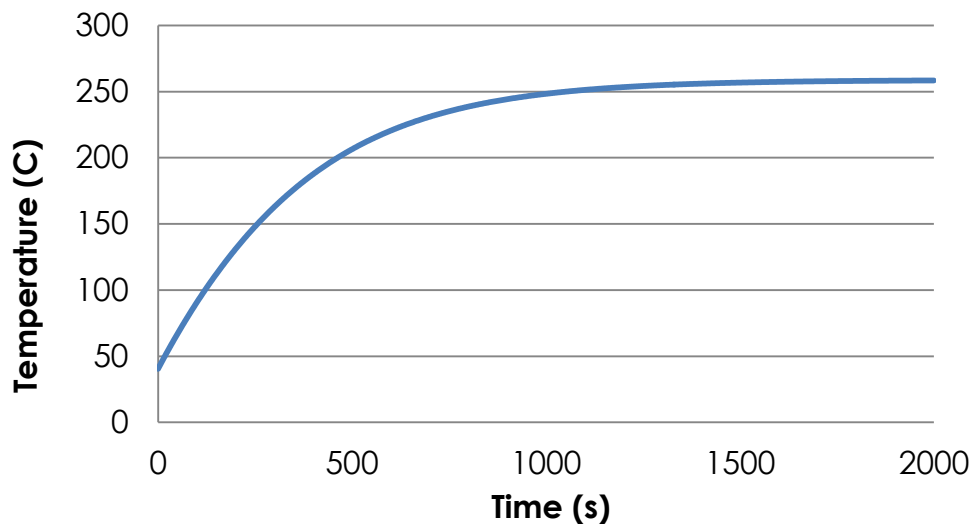
Thus, the expression (VII.i.4) [44] used to calculate the rate of change of the temperature with respect to time is

$$m_{\text{cont}}c_p \frac{dT_{\text{cont}}}{dt} = q_{\text{rad,in}} - q_{\text{rad,out}} - q_{\text{conv}} \quad (\text{VII.i.4})$$

Here,  $m_{\text{cont}}$  is the mass of the fluid and its container, and  $c_p$  is the specific heat capacity of the fluid and the container. This equation was solved computationally with the values summarized in Table VIII.i.1 [2], [45], and assuming the working fluid would be olive oil [46]. The area of the container allows for 1kg of olive oil to be heated. The area of the collector is chosen because the size of the collector affects the maximum steady state temperature of the olive oil. The  $A_{\text{col}}$  chosen in Table VII.i.1 is the size required to heat 1kg of oil to 260°C.  $T_{\text{amb}}$  represents the average value of the ambient temperature of Rajasthan over one year. The result is depicted in Figure VIII.i.4. This analysis was done in Engineering Equation Solver and the code can be found in Appendix A.

**Table VII.i.1.** Parameters used in the simulation.

Parameter	Given Value
$\alpha$	1
$\varepsilon$	1
$\rho$	0.95
$A_{\text{col}}$	2 m <sup>2</sup>
$A_{\text{cont}}$	0.089 m <sup>2</sup>
$c_p$	1670 J/kg-K
$I$	454 W/m <sup>2</sup>
$T_{\text{amb}}$	42°C



**Figure VII.i.4.** Temperature as a function of time from the numerical simulation.

This model can be compared to experimental data gathered from a prototype. Within the testing section of this paper, the prototype testing is compared to theoretical calculations.

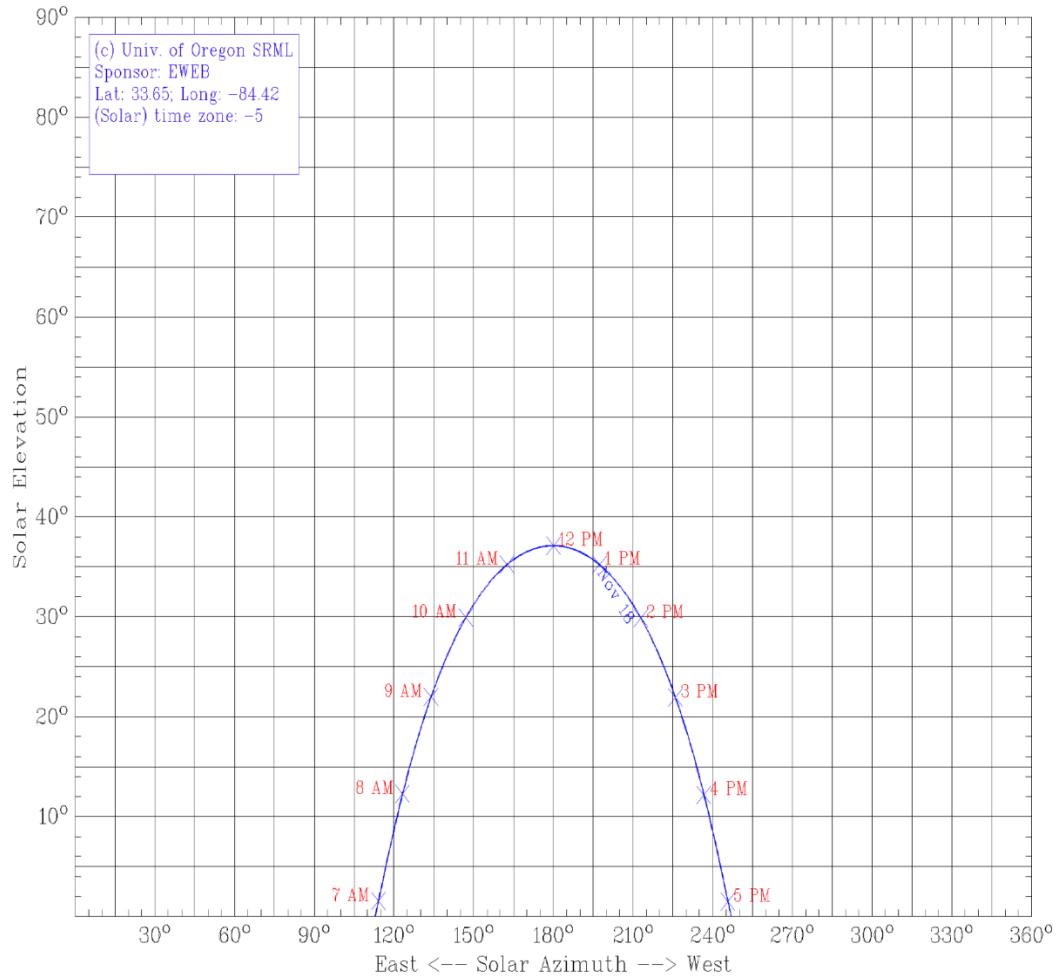
### Collection: Testing

Two aspects of the prototype collector were tested to study the efficiency of the design. The alignment was tested by observing how long the collector, if set at correct angles based on the time of year and day, would heat up the olive oil before the collector was rendered unusable based on the time of day. The maximum temperature of the olive oil based on the size of the collector was also tested. Both mechanisms of the collector were compared to mathematical models.

### Alignment

To test the efficiency of the solar collector based on the angle it is set at, a test was run based on the time of day, day of the year, latitude and longitude. The experiment was run on November 18<sup>th</sup>, 2011 at 2:00PM in Atlanta Georgia

where the Latitude is  $33.65^\circ$  and the Longitude is  $-84.42^\circ$  [47]. Based on these values a chart was created to find the Azimuth and Zenith angles for the solar collector. Figure VII.i.5 shows these angles based on the time of day. The Azimuth angle used was  $225^\circ$  and the Zenith angle was  $30^\circ$  [43]. Insolation, which also depends on location and time of year, was taken as  $4.13\text{kWhr/m}^2$  [48]. The time of day affects the amount of time needed to heat the oil to steady state, presuming the collector is properly aligned. The collector was said to be out of alignment when the light concentration created by the mirrored acrylic was no longer focused onto the pipe holding the olive oil. Through testing multiple times during the day it was seen that the angles of the collector needed to be changed, on average, every 23 minutes or no energy would be collected. This shows that for the system to work these angles must be adjusted at the determined time or no solar energy would be collected. Angle adjustments this often presents a difficult task since the villagers are not going to adopt the system if they must continually adjust the collector for it to work. This issue and its solutions will be addressed later in the paper.

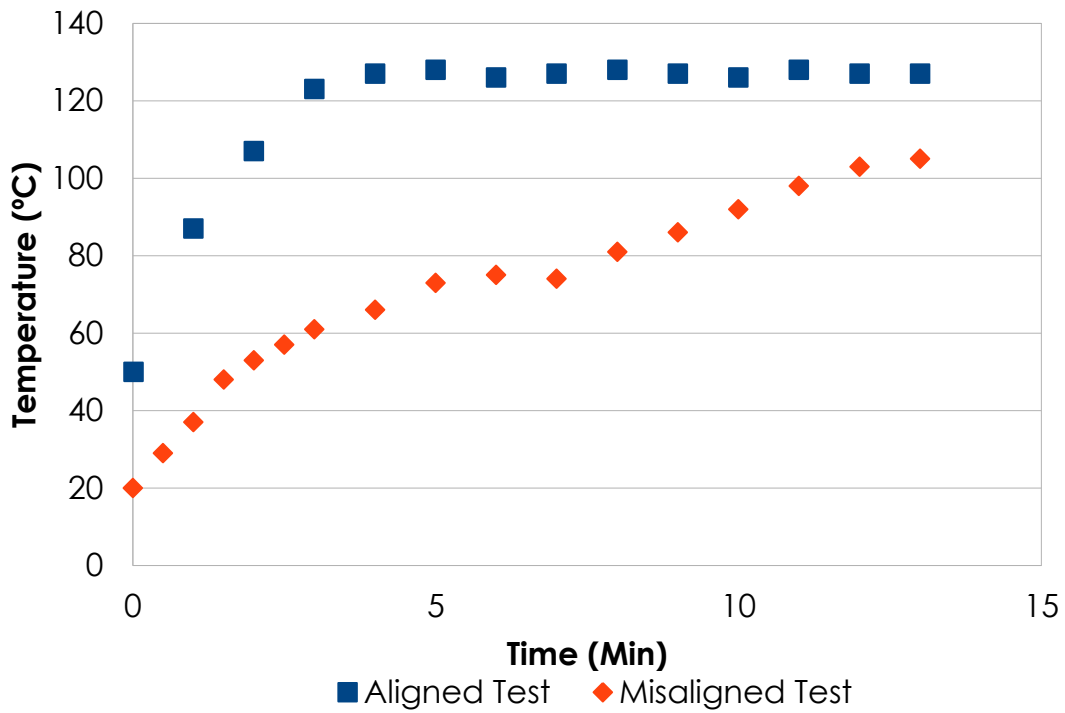


**Figure VII.i.5:** Azimuth and Zenith Angles for Atlanta GA, on Nov 18, 2011

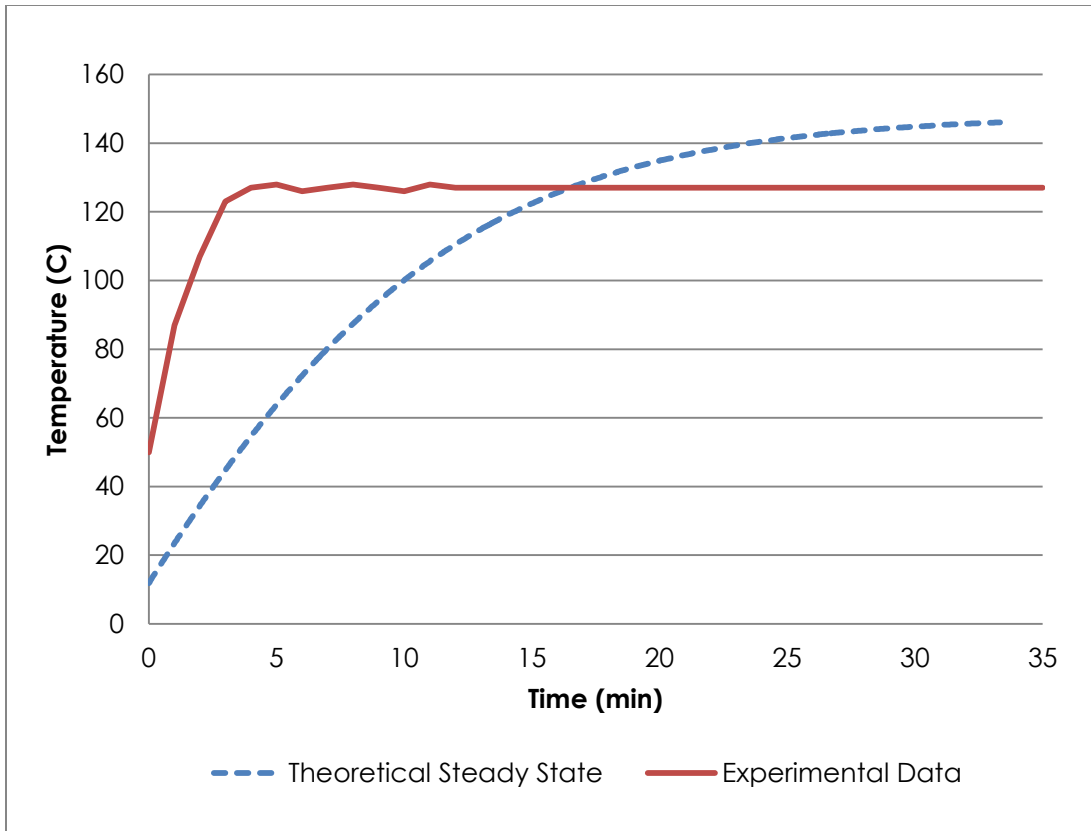
### Heating

For the heating of the oil it was observed that, with a collector surface area of 0.588 m<sup>2</sup> and oil volume of 0.000261m<sup>3</sup>, steady state temperature is 127°C. To reach this steady state it took an average of 6-7 minutes. Figure VII.i.6 shows temperature as function of time at 2:30PM on November 18, 2011. Plotted on the same figure are data taken when the mirrors were not aligned correctly to show the drastic difference in temperature rise when all of the mirrors are not precisely focused onto the pipe holding the oil. The temperature rise is much lower and takes longer. A few adjustments can be seen in the graph at 7 minutes, when the other test saw steady state, and another

temperature jump occurs. Again however the temperature tapers off and reaches a steady state well below the perfectly aligned test.



**Figure VII.i.6:** Temperature vs. Time for collector when aligned and misaligned



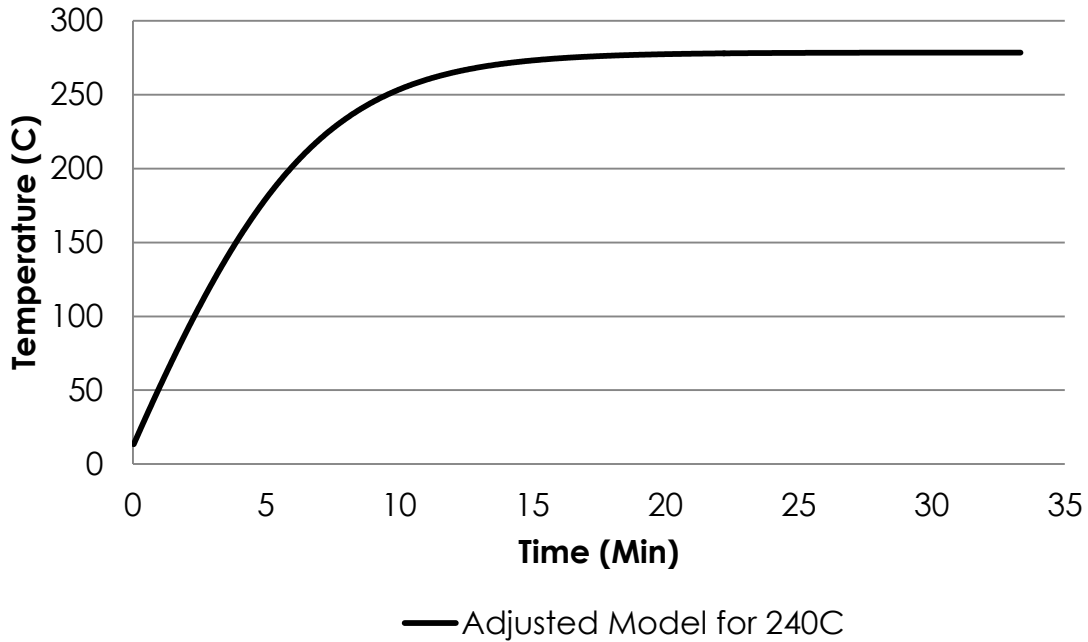
**Figure VII.i.7** Comparing collection model and experimental data

Figure VII.i.7 shows the model compared to the experimental data. The steady state temperature shown by the model when using the volume of oil and collector size from the prototype is 146 °C. The theoretical model predicts a steady state temperature 19°C above the data collected. However, the rise to steady state takes considerably longer than the model predicts. A possible reason for this difference could be due to the absorbtivity and emissivity assumption being too high or the model of the oil in the tube is over simplified. The error between the experimental data and the theoretical is 14.8%. This allows us to calculate an efficiency value for the collector system. When scaling this model to proper size the efficiency will be used and assumed constant, no matter the size of the collector. This will allow for the model to be adjusted and a proper collector size to be found.



Using an efficiency rating of  $\eta=86.2\%$  and the desired oil steady state temperature of  $240^{\circ}\text{C}$ , the model found that the collector must be  $1.165\text{ m}^2$ . This was calculated using the lower bound Insolation value within Rajasthan of  $4.76\text{kWh/m}^2$  and the ambient temperature of  $15^{\circ}\text{C}$  to ensure the values were correct.

To find the time to heat the oil using an area of  $1.165\text{ m}^2$ , the time to reach within a 2% error of steady state was analyzed, comparing the tested values and model values. The prototype, with a collection area of  $.54\text{m}^2$ , reached within 2% error of  $128^{\circ}\text{C}$  in 7 minutes. The model, using the same parameters of size and ambient conditions, took 29.37minutes to reach a steady state temperature of  $146^{\circ}\text{C}$ . The time to reach steady state within the model is exaggerated compared to the actual time to reach steady state because the model does not account for the insulation installed on the system which prevents radiation from the pipe containing the hot oil. Using the ratio between the model and the experimental time to steady state, the true time to reach steady state can be attained while factoring in the efficiency of the collector. Figure VIII.i.8 shows the temperature of the oil as a function of time using the size of the collector needed and taking into account 86.2% efficiency. The time it takes to reach within 2% error of steady state is 16.95 minutes and the ratio taken previously is 4.2. This calculation provides an accurate time to reach steady state of  $240^{\circ}\text{C}$  using the collector designed as 3.86 minutes.



**Figure VII.i.8:** Time taken to reach 240C using 1.165m<sup>2</sup> collector, considering efficiency

With a heating time known, a flow rate can now be calculated for the oil through the solar collection tube. A correct flow rate ensures that the entire amount of oil needed for 4kW of energy is heated. The tube has a volume of 0.000261 m<sup>3</sup>, and the density of olive oil is 900 kg/m<sup>3</sup> [46]. By multiplying the volume and the density the mass of the olive oil can be found. Using Equation VII.i.5 the mass flow rate can be found of the system, by using the time approximated to heat the oil to a desired temperature.

$$\dot{m} = \frac{V\rho}{t} \tag{VII.i.5}$$

where  $V$  is the volume,  $\rho$  is the density of the oil and  $t$  is the time in seconds to heat the oil to the desired temperature. Table VII.i.3 displays the constants and calculated values for the flow rate.

**Table VII.i.3:** Calculated values

<b>Inner Diameter</b>	0.0191 m
<b>Length</b>	0.914 m
<b>Cross Section A</b>	0.000287 m <sup>2</sup>
<b>Density [46]</b>	900 kg/m <sup>3</sup>
<b>Volume</b>	0.000261 m <sup>3</sup>
<b>Mass (Calc)</b>	0.2357 kg
<b>Mass Flow (Calc)</b>	.00101kg/s

This mass flow rate is small and will be difficult to control due to the fact that oil's viscosity changes as the temperature increases and the pipe is not frictionless. To make the system more robust, a better way to set the Azimuth and Zenith angle must be found. Also, a different material that did not need to be aligned perfectly would aid in the adoption of the system. The lower the difficulty level the more apt the system is to be adopted by the villagers. More insulated piping and containers would also be useful in all other area besides the solar collector so that heat is not lost during transit from tank to output. If not better piping, insulation could be added around other sections to prevent heat loss. To more accurately fix the flow rate a more efficient pump could be used. All of these factors could help improve the efficiency of the collection system of 86.2% and thus the overall system efficiency.

### **VII.ii Storage Subsystem**

After the oil is heated in the solar energy collector subsystem, the oil will flow down to a tank where it will be stored until the user wants to use it. This system needs to insulate the oil so that the oil remains hot from the day to evening for dinner and into the morning for breakfast. The system is buried because sand is a relatively good insulator. Even though air has a lower thermal

conductivity than sand, if the tank was left above ground it would be exposed to convection which would cause significant heat losses.



**Figure VII.ii.1** Schematic of the storage tank

### **Storage: Mathematical Model**

For the storage analysis, two forms of insulation were examined. The first form of insulation was a semi-infinite amount of insulation around the cylindrical tank. The second method was to bury the tank under the ground.

To calculate the heat flux for the semi-infinite insulated tank, the thickness of the insulation was first calculated using Equation VII.ii.1 [49]

$$x = 4\sqrt{\alpha t} \quad (\text{VII.ii.1})$$

where  $\alpha$  is thermal diffusivity,  $t$  is time the fluid needs to stay heated, and  $x$  is the insulation thickness. Thermal diffusivity is calculated by Equation VII.ii.2. [44]

$$\alpha = \frac{k}{\rho c_p} \quad (\text{VII.ii.2})$$

Next, the thermal resistance is calculated using Equation VII.ii.3

$$R_{\text{semi-inf}} = \frac{1}{h_{\text{fluid}}\pi D_{\text{tank}}L} + \frac{\ln\left(\frac{D_{\text{ins}}}{D_{\text{tank}}}\right)}{2\pi k_{\text{sand}}L} \quad (\text{VII.ii.3})$$

where  $h_{fluid}$  is the convective heat transfer coefficient of the fluid,  $D_{tank}$  is the diameter of the tank,  $D_{ins}$  is the insulation thickness in addition to the diameter of the tank,  $k_{sand}$  is the thermal conductivity of the sand used for insulation,  $L$  is the length of the tank [44]. Now, the thermal resistance can be used to calculate the heat flux through the tank represented by equation VII.ii.4

$$q_{semi-inf} = \frac{T_{tank} - T_{sand}}{R_{semi-inf}} \quad (VII.ii.4)$$

where  $q_{semi-inf}$  is the heat flux calculated with a semi-infinite amount of sand for insulation,  $T_{tank}$  is the temperature of the fluid in the tank, and  $T_{sand}$  is the temperature of the sand [44].

To calculate the heat flux when the tank is buried equations VII.ii.5-VII.ii.6 where used [44].

$$S = \frac{2\pi L}{\text{arccosh}\left(\frac{2Z}{D}\right)} \quad (VII.ii.5)$$

$$q_{buried} = Sk_{sand}(T_{tank} - T_{sand}) \quad (VII.ii.6)$$

where  $S$  is the shape factor and  $q_{buried}$  is the heat flux of the tank underground. The insulated tanks were also compared to the tank when it was not insulated. This was done with equation VII.ii.7

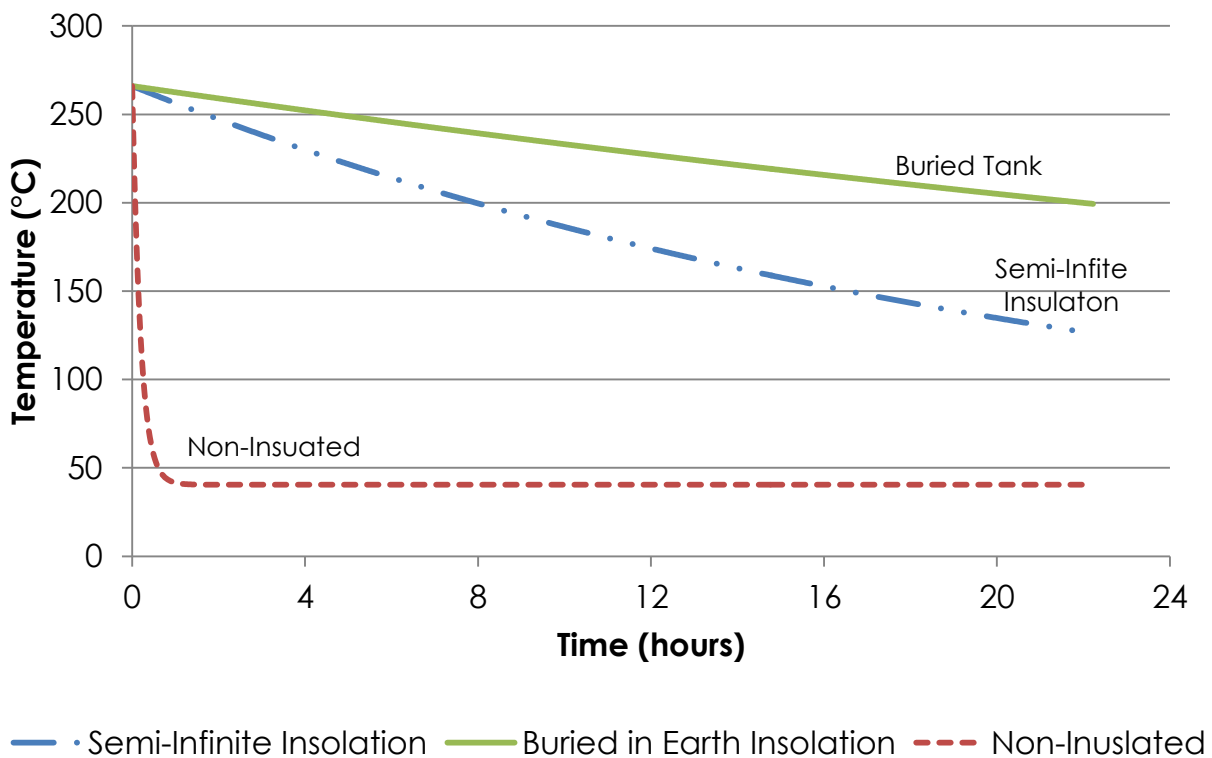
$$q_{no-ins} = hA_{surface}(T_{tank} - T_{amb}) \quad (VII.ii.7)$$

where  $q_{no-ins}$  is the heat flux without insulation,  $h$  is the convective heat transfer coefficient, and  $T_{amb}$  is the temperature of the air [44].

With these results a numerical integration was performed to determine the temperature as time progressed. This can be done by numerically solving the heat flux equation (VII.ii.8)

$$q = mc_p \frac{\partial T}{\partial t} \quad (VII.ii.8)$$

where  $q$  is the heat flux,  $m$  is the mass of the fluid storing the heat,  $c_p$  is the specific heat of the fluid, and  $\frac{\partial T}{\partial t}$  is the instantaneous change in temperature over the change in time [44]. The numerical integration to find temperature as function of time was done in a program called Engineer Equation Solver. Appendix D shows the code used to solve this problem. Vegetable oil was assumed to be the fluid used in the system, which has a specific heat of 1.67 kJ/(kgK) [50]. Figure VII.ii.2 shows the temperature profile as function of time for oil for a non-insulated tank, a semi-infinite insulated tank, and a buried tank. This theoretical data shows that burying the tank underground will insulate it better than a tank with 0.348 m of sand, although both insulation methods show good insulation. The buried tank will hold the temperature above 200°C for 18 hours, if the oil temperature starts at 266°C, which was shown to be possible in certain conditions.



**Figure VII.ii.2.** Temperature as a function time for insulated and non-insulated storage tank

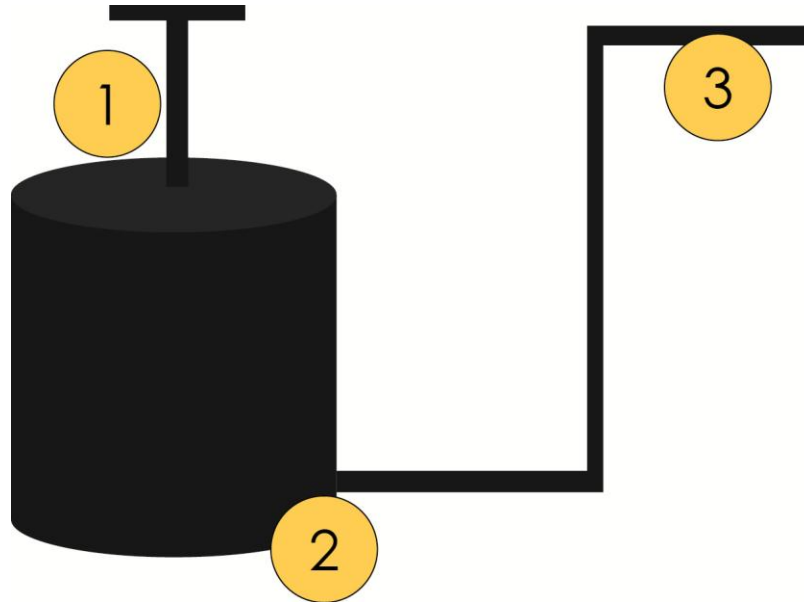
The pressure required to move the fluid from the storage tank at the correct velocity needs to be determined. This can be done by using Bernoulli's equation and conservation of mass. Major assumptions that need to be made use the principle of Bernoulli's equation include that the fluid is incompressible and inviscid, that the flow is steady, and that the system is frictionless. The assumption that the pipe is frictionless is not entirely accurate, but it gives a starting point. The assumption that the flow is incompressible implies that fluid will not change density along the stream line. To make this assumption it will be presumed that the fluid is at a constant temperature from the tank to the stove; therefore the fluid's density will not change as the temperature does. The density change in vegetable oils is only 6.7% of 100°C, thus the density change at the stove due to a decrease in temperature will be assumed to change the equation negligibly [46].

Bernoulli's equation is given by equation VII.ii.9

$$P + \frac{\rho V^2}{2} + \rho g z = \text{const} \quad (\text{VII.ii.9})$$

where  $P$  is pressure,  $\rho$  is density,  $V$  is the velocity of the fluid,  $g$  is the gravitational acceleration constant, and  $z$  is the height [51]. Figure VII.ii.3 shows the different points that were analyzed with Bernoulli's. The analysis of the system starts at point 3, where the  $P=0$  Pa because the fluid is at atmospheric pressure when it is released,  $z=0$  m because this is the starting reference point, and the velocity will be determined by the desired mass flow rate for the optimum heat transfer at output. At position 2, the velocity is assumed to be the same as at the output, for now  $z=1.8$  m, from here the pressure at the bottom of the tank can be calculated. The velocity is the same at position 2 as position 3 because it is traveling through the same cross sectional area pipe, and the volumetric

flow rates must be the same. Since the velocity at point 2 is the same as the velocity at point 3, the pressure at the bottom is independent of the velocity. The pressure was determined to be 16.1 kPa.



**Figure VII.ii.3.** Diagram of storage tank marking the different points analyzed.

Using the optimum mass flow rate, the velocity of the fluid is determined by Equations VII.ii.10 and VII.ii.11

$$Q = \rho \dot{m} \quad (\text{VII.ii.10})$$

$$Q = VA \quad (\text{VII.ii.11})$$

where  $Q$  is the volumetric flow rate,  $\dot{m}$  is the mass flow rate, and  $A$  is the cross sectional area [51]. Once the pressure is determined for point 2, the pressure for point 1 can be determined by the same method, assuming the radius of the tank is 0.05 m. Once the pressure for point 1 is found, Equations VII.ii.12 and VII.ii.13 are used to find the piston mass needed to provide the required pressure.

$$P = \frac{F}{A} \quad (\text{VII.ii.12})$$

$$F = ma \quad (\text{VII.ii.13})$$



where  $F$  is the force needed,  $m$  is the mass needed, and  $a$  is the acceleration in this case the gravitational constant. Table VII.ii.2 shows the mass and pressure needed for various flow rates.

**Table VII.ii.2.** Mass for given mass flow rate analysis

$\dot{m}$ (kg/s)	Q (m <sup>3</sup> /s)	V at 3 (m/s)	h at 2 (m)	h at 3 (m)	P at 3 (Pa)	P at 2 (Pa)	V at 1 (m/s)	z at 1 (m)	P at 1 (Pa)	m (kg)
0.01	9	0.005	1.82	0	0	16069	0.47	0.61	5485	29.1
0.03	27	0.014	1.82	0	0	16069	1.41	0.61	6275	33.3
0.05	45	0.023	1.82	0	0	16069	2.34	0.61	7857	41.7
0.08	72	0.036	1.82	0	0	16069	3.75	0.61	11713	62.2
0.10	90	0.046	1.82	0	0	16069	4.69	0.61	15272	81.1
0.15	135	0.068	1.82	0	0	16069	7.03	0.61	27631	146.7
0.20	180	0.091	1.82	0	0	16069	9.38	0.61	44933	238.6
0.30	270	0.137	1.82	0	0	16069	14.06	0.61	94367	501.0
0.50	450	0.228	1.82	0	0	16069	23.44	0.61	252555	1340.9

## Storage: Testing

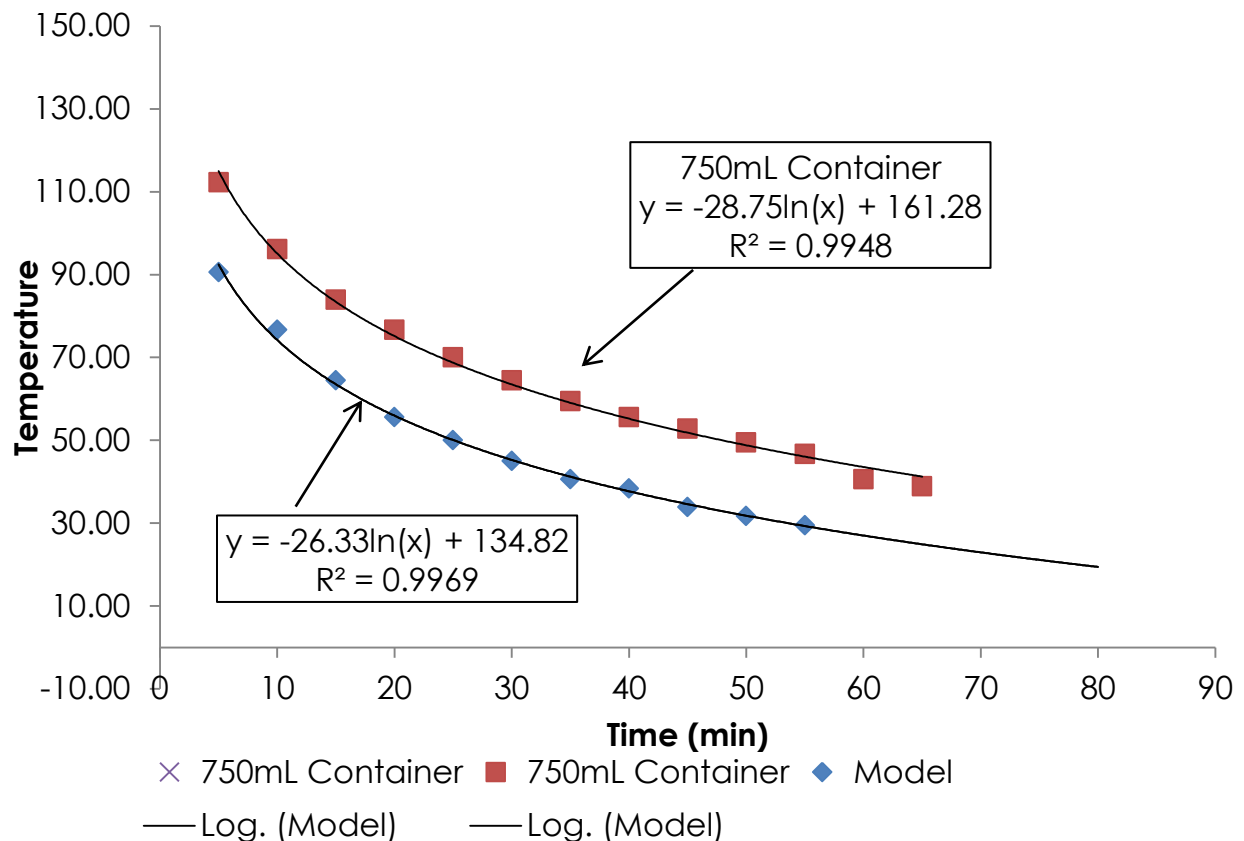
The model for insulating the tanks was done on a small scaled. First olive oil was heated to 112°C and 142°C temperature, and then the it was poured into an aluminum can. The can's contents had been extracted through a small hole; the whole was later used to pour the oil into and place the thermometer in the can. The can was then buried in the ground and the temperatures were recorded every five minutes as it cooled down. The temperature of this small container was expected to drop more quickly than the large oil container because there is more surface area per unit volume. However, if the model is run under the same conditions as the experiment is a relative efficiency can be found. Using this efficiency, the expected temperature drop of the full size model can be determined.

Figure VII.ii.4 shows the testing results of several different size containers. It is seen the container holding a larger volume of oil retains its heat for longer, as expected. Additionally, the data was fit to a logarithmic curve. The fit is shown with Equation VII.ii.14 and VII.ii.1 for 750 mL container and the 400 mL container respectively.

$$y = -28.75 \ln x + 161.28 \quad (\text{VII.ii.14})$$

$$y = -26.33 \ln x + 133.82 \quad (\text{VII.ii.15})$$

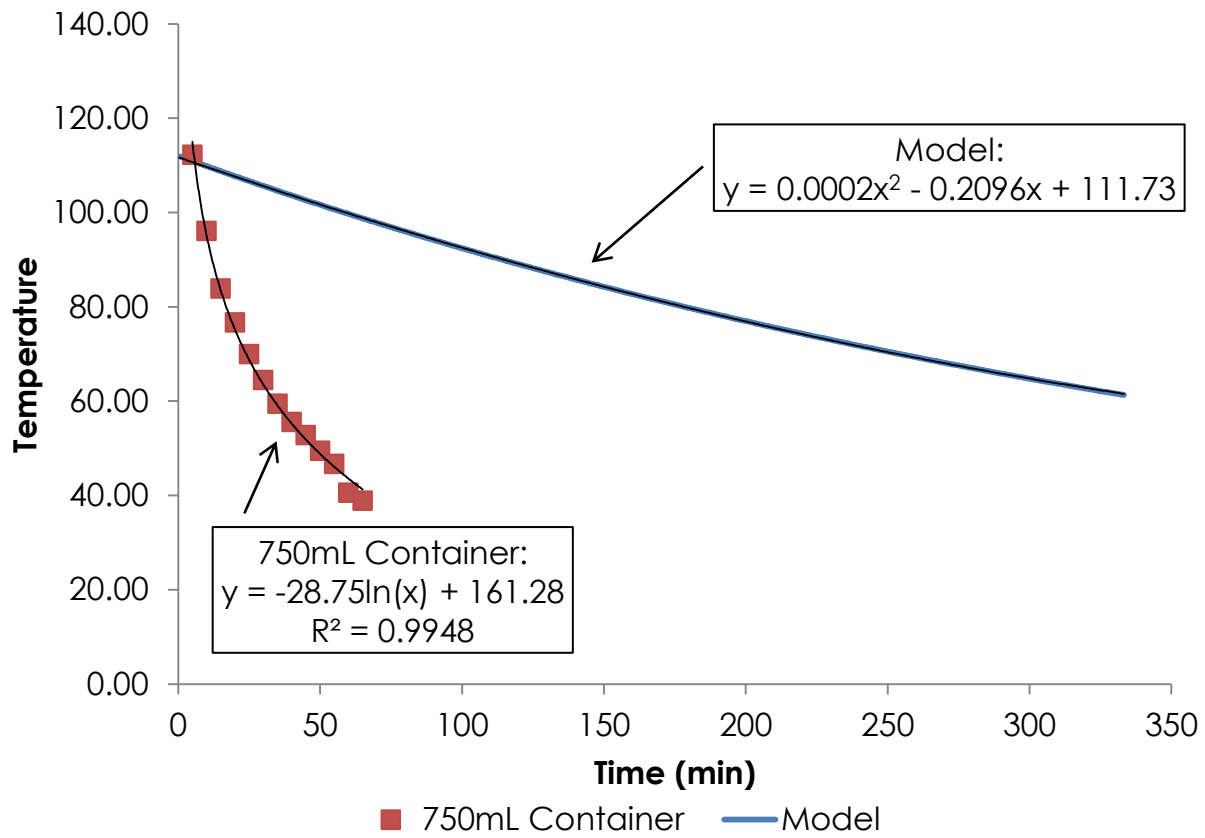
The  $R^2$  values are 0.9948 and 0.9969 for the 750 mL container and the 400 mL container which shows the fits are relatively good since they are close to 1.



**Figure VII.ii.4** Insulation testing data

Figure VII.ii.5 shows the largest container with the modeled data. They do not show similar trends. For this short period of time, less than 2 hours, the model does not drop off quickly or in the logarithmic trend that the actual data does.

This shows that one testing for a larger amount of oil should be done and that the model should be modified. The huge error in the model is due to fact that simplifications were done to model the temperature in three-dimensions. This was not accurate, a nodal analysis will need to be done in order to get a more accurate model. Overall, the insulation proves to be inadequate. More testing should be done on a larger scale and an improved insulation system is necessary for the success of this product.



**Figure VII.ii.5** Cooling data compared to cooling model

### VII.iii Output Subsystem



**Figure VII.iii.1** Schematic of heat output subsystem

The output subsystem consists of thin metal copper tubing coiled to form a stove top. The user will pump hot oil through the piping to heat the stove. This will be a closed system, in order to maximize the heat extracted and that the safety of the user. After cooking, the fluid will be re-pumped back through to the storage tank for the collector.



**Figure VII.iii.2** Schematic of cookstove

### **Output: Testing Procedure**

---

A cooking surface that consists of a coiled copper tube was tested by making boiling water and hot olive oil flow through it. The oil experiment was performed having the liquid flow at three different flow rates. Table VII.iii.1 summarizes the results of the experiment.

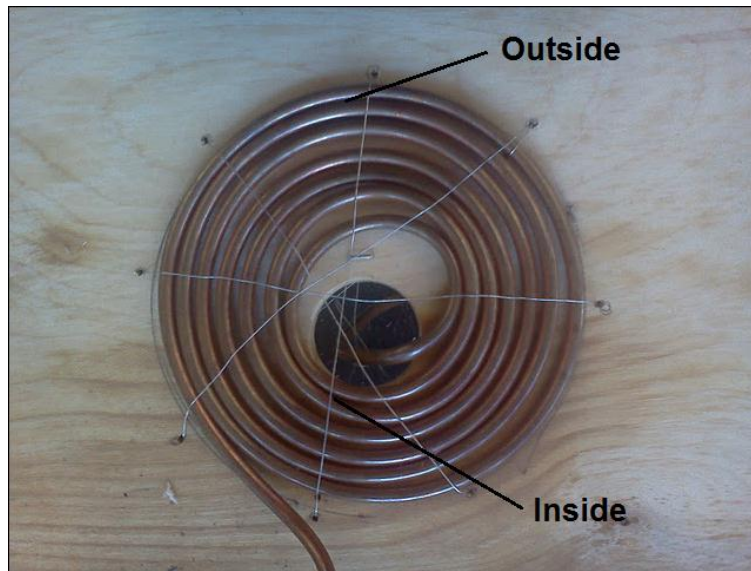
**Table VII.iii.1** Heat dissipation experimental results

Fluid	Flow Rate (cm <sup>3</sup> /s)	Fluid Inlet Temperature (°C)	Coil Steady State Maximum Temperature (°C)	Coil Steady State Minimum Temperature (°C)
Water	11.6	99.3	93.3	92.8
Olive Oil	6.9	204	187	158
Olive Oil	8.85	204	186	163
Olive Oil	10.4	204	195.6	156

Figure VII.iii.3 shows the setup of the experiment with water. The ambient temperature was 20°C. The temperature of the coil before the experiment started was measured to be 22.8°C. The water at 100°C was poured through the funnel at a flow rate of 11.6 cm<sup>3</sup>/s, and the temperature of the coil was measured in the outer and the inner area of the coil, as shown by Figure VII.iii.4, every 10 seconds. The coil steady state maximum temperature was measured on the outside, and the minimum in the inside.

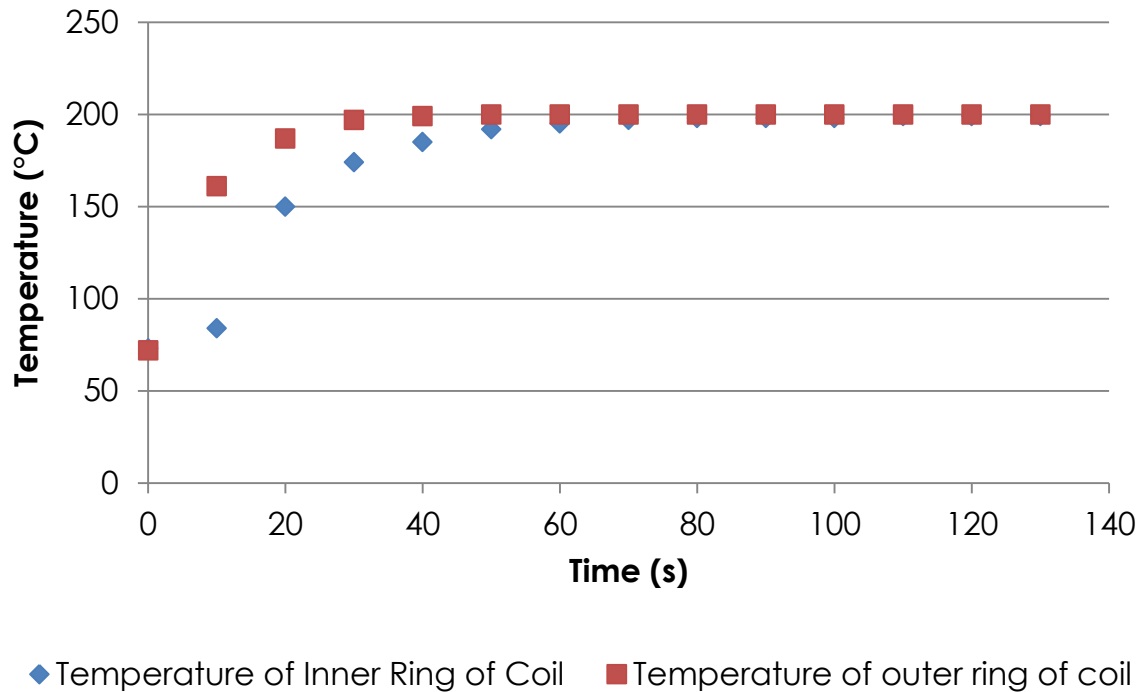


**Figure VII.iii.3** Heat dissipation coil experiment setup.



**Figure VII.iii.4** Thermometer placement inside and outside of the coil.

Figure VII.iii.5 depicts the results of the experiment. The coil reached thermal equilibrium after 80 seconds. The temperature of the water as it fell in the collecting bucket was measured to be  $83.9^{\circ}\text{C}$ . This is much lower than expected based on the steady state temperature in the inside of the coil. This was due to the fact that the fluid fell freely 50 cm before it was collected in the bucket at which point its temperature was measured.



**Figure VII.iii.5** Coil temperature as a function of time

The same procedure was followed for olive oil, three different times. The higher the height at which a fluid starts flowing the higher its potential energy and therefore, the higher its velocity when it flows through the coil. Each time a longer pipe inlet extension was used in order to obtain different flow rates. The initial temperature of the fluid was 204°C every time, but the outlet temperatures for each of the flow rates in order of increasing magnitude were 154°C, 158°C, and 157°C respectively. In every case, thermal equilibrium was reached in 110 seconds or less, which confirms the feasibility of the system in terms of time of responsiveness to user input.

### **Output: Mathematical Model**

The experimental results determine the assumptions that can be made in the model. Namely, there are two ways the analysis can be done: assuming constant temperature along the coil, and assuming constant heat flux. The right



assumption can be easily identified by measuring the temperature at two different points of the tube. If the two measurements are sufficiently different, a linear gradient must be assumed and the second assumption applied. Evidently, the latter is the case for the olive oil experiments, which is the fluid to be used in the design.

In order to calculate how much heat is dissipated in steady-state conditions, Equation VII.iii.1 can be used.

$$q = \dot{m}c_p(T_{f,i} - T_{f,f}) \quad (\text{VII.iii.1})$$

Here,  $\dot{m}$  is the mass flow rate of the fluid,  $c_p$  is the specific heat capacity,  $T_{f,i}$  is the temperature of the fluid before it goes through the coil, and  $T_{f,f}$  is its outlet temperature. In order to calculate the input power to the system, Equation VII.iii.1 can be applied again. The temperature difference in this case must be the temperature the fluid was heated up to minus room temperature. With this information the system efficiency can also be calculated.

In the experiment performed, the temperature of the external surface of the pipe was measured and not the one of the fluid inside of the coil. The constant heat flux assumption, however, allows for another presumption to be made. Fourier's law (Equation VII.iii.2) shows that the length specific heat is proportional to the difference of the inside and outside surface temperatures of the pipe.

$$q' = \frac{2\pi k}{\ln(r_2/r_1)}(T_{s,1} - T_{s,2}) \quad (\text{VII.iii.2})$$

In this expression,  $k$  is the thermal conductivity of copper, and  $r_1$  and  $r_2$  are the inside and outside radii of the tube. If the heat flux is to remain constant along the coil, the temperature difference must too. Assuming the temperature of the inside wall of the tube is the average temperature of the fluid and presuming negligible fluid temperature drop through the insulated funnel conduit, the fluid temperature in the inside area of the coil can be found by adding the temperature difference between that of the fluid at the inlet and the one on the

outside area to the temperature measured on the surface of the pipe in the inside area.

### Output: Experimental Results Analysis

The above theoretical analysis can be applied to the data collected during the olive oil experiments in order to obtain insight on the performance of the system. This is how Table VII.iii.2 was produced.

**Table VII.iii.2** Experimental Analysis

Vol. Flow Rate (cm <sup>3</sup> /s)	Mass Flow Rate (kg/s)	T <sub>coil,out</sub> (°C)	T <sub>fluid,inlet</sub> (°C)	T <sub>coil,in</sub> (°C)	T <sub>fluid,outlet</sub> (°C)	Avg. Coil Temp. (°C)	q <sub>out</sub> (W)	q <sub>in</sub> (W)	η
6.9	0.00621	187	202	158	173	172.5	355	2165	0.16
8.85	0.007965	186	202	163	179	174.5	361	2777	0.13
10.4	0.00936	195.6	202	156	162	175.8	730	3264	0.22

The efficiency of the system was calculated using Equation VII.iii.3.

$$\eta = \frac{q_{out}}{q_{in}} \quad \text{(VII.iii.3)}$$

From these results, it is evident that there is a correlation between the power delivered and the flow rate of the oil through the coil. The higher the flow rate, the higher the heat dissipated into the element being cooked and, also, the higher the average temperature of the cooking surface. There seems to be a direct correlation of this quantity with efficiency as well, but the results are not conclusive in this regard. However, optimizing the cooking surface temperature and heat delivered would be sufficient to consider the system successful

### VII.iv Human interactions

The above technical details must be implemented so that the device serves users motivating them to use it by representing an improvement in their quality of life without disturbing their day to day customs and traditions. Four aspects of the proper usage of the cook stove have been identified as the

reasons the users would have to handle the device, namely, installation, adjustment, cooking, and maintenance.

The installation is, perhaps, the most challenging interaction for the user. For a lasting system, pipes and fittings would have to be precisely assembled between the three subsystems. A special complication arises with the need of burying the storage tank. Because of this, it is recommended that a small group of people in the village where the system is to be implemented be given a specialized training on this job, when the device is deployed. Even though the task requires some level of specialization, no skilled labor would be required. The training would consist exclusively on details specific to the cook stove.

During the day, as the solar energy is stored in the working fluid, several steps have to be taken in order for the system to work. For instance, the angle of the collector must be adjusted by hand regularly in order for it to perform its function. This was determined to be the most feasible and cost effective solution for this component of the system. There is a valve between the collector and the storage tank that must be adjusted by the user in the morning so that the fluid flows and heats at the same time.

The most important portion of the interaction with the solar cook stove is, of course, cooking. The average anthropomorphic features of the population of Rajasthan have been taken into account in the physical design of the output subsystem. The main feature being that the women cook sitting down in traditional areas of India. This aspect of the design is very important to the successful adoption of the stove. The design has been finalized in a way that the stove is personalized by the woman who uses it. By making it out of clay, they are able to form the height and width of the stovetop support. With this need to sit down comes also a way to turn the stove on and off as well as adjust the temperature output. Out of the other options considered, it has been determined that the most feasible solution for user control of the stovetop is to use a pump to vary the flow rate, and thus the temperature. For now, the design

consists of a manual foot pump, however ideally the pump would be automated and could be adjusted similar to an electric stove temperature knob.

The geographical area where the cook stove will be implemented is a desert, thus covered in sand. This will cause the solar collector to become dirty and drop its efficiency significantly. The users will have to check the cleanliness of the surface of the collector daily to ensure that a sand coating does not form and block the reflectivity of the solar collector. Also, filters will need to be attached to the piping at the elevated cold oil reservoir so that sand does not enter and clog the piping system to the output. User's will need to take note of efficiency losses of their stove tops and find someone from the maintenance crews to inspect if there are any clogs due to sand in their pipes.

It is clear that in order for the device to work properly, several people with some level of training would have to be involved in the constant handling of one device. Even though the best approaches in the design of the components in terms of human interaction have been pursued during the given timeframe to complete the project, the current design still requires certain undesirable interactions from the user. Section X of this report addresses the possibilities to explore if work on this device is to be continued.

## **VIII. Sustainability Considerations**

The goal of this project is to make the way of life of Indians in rural Rajasthan more sustainable. Currently, women have to walk an average of 2.5km a trip to collect wood and make upwards are 16 trips a month to collect wood [35]. This totals to about 50 hours of wood collection a month[52], and the situation is becoming more serve as the available fire wood gets more scarce. In northern Indian, 99% of people use biofuel to cook and heat their food [1]. Furthermore, 87% of these Indians use either wood collected or bought from the

local market as their source of fuel [35]. [1]. Hence, burning wood for fuel is not a sustainable practice for the environment or the lifestyles of Indian villages. This solar stove can bring a solution to the need for sustainability in Rajasthan.

Besides maintenance the solar stove will be a completely sustainable system. The olive oil does not evaporate in air and can be replaced if it becomes contaminated [53]. Because the system is almost completely closed, except for the cold reservoir tank which is not sealed tight, there will be little chance for contamination of the oil. This also leads to minimal loss of oil over time. This allows for the stove to be only dependable on solar energy on a daily basis. Unlike wood or other bio fuels which can only be used once per use, this system is sustainable and run on renewable energy.

The olive oil will not have corrosive effects on the copper tube and steel tanks unless water gets into the pipe [54]. Thus, the system needs to be sealed tight. This means failure will not occur based on olive oil exposure or temperature exposure. The rest of the system then is easily sustainable and can have basic repairs performed on it by maintenance workers.

In order for this system to provide a sustainable solution for Rajasthan, the stove must also be integrated into the lifestyles of Rajasthani. Specifically, it must be adopted by the women, who are the ones that predominately cook and collect wood. Two major things must be accomplished: first, the system must fit into the culture and lifestyle of the women seamlessly and second the system's technology must be appropriate for the area while still meeting the needs of the users. The appropriate technology specifications have been addressed in the Design Overview. The system specifications address the culture and lifestyle of Rajasthani women. Thus, the system needs to provide energy in evening and the morning when the sun is not out. The cook top should be positioned such that the women can cook sitting down and hold their children, as well as allow the women can cook in the privacy of their own homes so that their families do not feel judged by community. In terms of appropriate technology, the system

must be to be built and constructed by the locals. This means that the solutions that would work in the United States and other first world countries are not an effective solution for area. The resources and the technical knowhow are limited in Rajasthan, so the system must be designed with these limitations in mind. The system is built without electronics and around simple science. Additionally, the system is easily understandable within the framework of understanding of Indian and thus can be constructed and repaired by locals.

Creating a sustainable product that is implemented well means that the system can not only be a solution for deforestation. The stove must help break the cycle of poverty. To aid in turning this product into a sustainable solution, groups of villagers will be trained, and paid, to act as installation and maintenance crews. They will also act as the informants on this new technology and help to educate local villagers, as well as other village's population, on the health and environmental impacts of their wood burning stoves. By first creating employment and secured funds the SolAr solar cookstove can empower villagers to use alternative energy for a healthier lifestyle for themselves and the environment.

These crews will be paid by Climate Healers to provide maintenance to families who encounter issues with their stove. The maintenance will be free to the users, to encourage use, and will also be continual support in educating them of the system. Climate Healers has also previously provided monetary incentives based on usage of new technology to villagers. A similar plan will be implemented with the solar stove at first to promote usage of sustainable technology instead of biomass for cooking. A way to monitor the usages based on time must be implemented and corruption of the incentive system avoided.

## IX. Materials and Cost Evaluation

Based on the constraints given for the project two of the most restricting ones were materials and cost. The goal is to make a solar cooker that could be made in rural Rajasthan with mostly local or easily available materials. The cost should to be under \$200, which with the multiple subsystems is difficult to achieve. The following sections describe some of the selection process for the materials, based on performance and price, of the subsystems followed by a cost evaluation for the entire solar cook stove. The price of the total system, based on materials alone, is approximately \$502.

### IX.i Energy Collection

Early in the investigation and research stage of the project, the team decided that the most cost efficient means to collect energy is a reflective collector. Photovoltaic systems cost an upward of 30000\$ to create 4kW-hr of energy and using a light refracting system, such as a large magnifying glass, will be too fragile and expensive. This decision was made, using a selection matrix, Table XIII.A.3, found in the appendix. For a reflective collector to work, an efficient shape is needed to optimize reflection. The other key element is a smooth, highly reflective material to cover the shape chosen with. Reflectivity is a material property, defined as the fraction of incident radiation reflected by a surface. Table IX.i.1 shows a list of materials with their respective reflectivity, cost per foot, as well as a general description of the advantages and disadvantages of the material.

**Table IX.i.1: Reflective Material Comparison**

<b>Material</b>	<b>Reflectivity [55], [56]</b>	<b>Price</b>	<b>Advantages</b>	<b>Disadvantages</b>
Polished Anodized Aluminum	95.00%	\$75/m <sup>2</sup>	Highly reflective for the price, lightweight. Durable and easily shaped.	Easily scratched.
Mylar	>98%	\$1.66/m <sup>2</sup> [57]	Highly reflective, light, cheap	Not good at standing up to the elements, forms 'bubbles' if glue starts to give, requires a rigid backing
Aluminum Foil	88%	\$0.34/m <sup>2</sup> [58]	Cheap and widely available	Not so reflective, corrodes when mixed with acidic juices, structurally weak
Can lids	70-80% (estimate)	Price of canned food	Common material and very cheap	Not very reflective, non-uniform shape is labor intensive to shape and use
Acrylic Mirror	99%	\$67.81/m <sup>2</sup> [59]	Very reflective (nearly 100%), nearly unbreakable	Comes in plane, very difficult to fit to parabola as a sheet. More expensive than most but long lifespan
Glass Mirror	99%	\$122.0/m <sup>2</sup> [60]	Very reflective	Expensive and comes in rigid plane, breakable and heavy
Astro-foil	76%	\$6.63/m <sup>2</sup> [61]	Strong and Reliable	Not reflective Enough

The highest reflective material at the lowest price is ideal for the project. A trade-off assessment is needed to determine whether or not a gain in reflectivity is worth a higher price. The trade-off assessment involves length of life, taking into account the desert environment of Rajasthan, as well as ease of construction of the collector using said material. The environment is key due to the high heat and sand, which can affect glue used to affix material. A material



with a reflectivity greater than 90% is needed for an efficient system, leaving polished aluminum, Mylar, acrylic mirror and glass out of the selection from Table IX.i.1. Mylar is the cheapest per m<sup>2</sup> however cannot be used alone based on the disadvantages of the material. It is easily affected by the elements, especially heat and sand, and must be affixed smoothly to be efficient. Glass mirrors are highly reflective however expensive, heavy and fragile, rendering them a poor choice for this application.

The prototype collector made by a previous team senior design team, NICARAGUA [62], has a reflective backing of Mylar with acrylic mirror strips oveltop as the main reflective material. The acrylic mirror is cut into thin strips that can be attached to a pre made shape. The strips allow for the material to be laid in parallel since the material is difficult to affix if it stays in the form of a sheet. Acrylic mirror strips are also light, easy to install and ship if need be. They do not break or scratch easily. Testing has proved that these strips will still reflect the desired amount of light, and the Mylar backing proves as a filler reflective material in between the strips of acrylic mirror. The Mylar could be used by itself, which allows for a low cost high reflective material; however, the environment of heat and sand could cause bubbles and wear and tear on the collector. Additionally, the parabola the needed to be cut more exactly because since the acrylic mirrors are a little thicker and thus can be more finely adjusted than the thin Mylar. Then, the user would need to apply it extremely smoothly which could prove difficult. Acrylic mirror on top of the Mylar will ensure that, as long as the mirror is attached well, the Mylar does not encounter the many problems it can have due to harsh environments that render it useless in the application of solar reflective collection.

The reservoir tank, insulation and piping that complete the collection subsystem were chosen to ensure maximum energy collection from the sun to the flowing oil. Metal pipes with high thermal conductivity are necessary to ensure that solar radiation reflected from the Mylar and acrylic can reach the oil

rapidly, increasing the efficiency of the system. Table IX.i.2 shows the various common piping materials possible for this, and other, subsystems as well as their corresponding thermal conductivities and melting point. Material selection charts plotting thermal conductivity based on price as well as thermal conductivity and service temperature are found in Appendix A.

**Table IX.i.2:** Piping Material Comparison

<b>Piping</b>	<b>Material</b>	<b>Thermal Conductivity, k (W/mK) [63, 64]</b>	<b>Melting Point</b>
Steel	Carbon Steel	54	1425-1540°C [65]
Copper	Copper	401	1084°C [65]
PEX	Cross-linked High-Density polyethylene	0.51	130°C [66]
CPVC	Chlorinated Polyvinyl Chloride	0.14	175°C [67]
PE	Polyethylene	0.38	110°C [66]
PVC	Polyvinyl Chloride	0.19	180°C [66]

The higher that the thermal conductivity of the material the faster that thermal energy can be conducted between the piping and the oil. The lower that the thermal conductivity is however, the better the material works as an insulator, which is also very important in maximizing the efficiency of the system. A thermal insulator or conductor versus price material selection chart can be found in Appendix A. This chart was used to decide many of the materials based on the system needs. Copper, with thermal conductivity of 401W/mK, is used as the collector pipe where the oil is to be heated. The piping that is

leaving the collector ideally would be one of the lower thermal conductivity pipes, however those are the polymers and have melting temperatures lower than the desired temperature of the oil. Insulation will have to be used instead to keep heat loss at a minimum during the day. The cool oil reservoir is made of steel. This will allow for the oil within the elevated reservoir to heat while exposed to the sun during the day and provide extra heating to the oil before it reaches the collector. Also, as the temperature of the oil in the reservoir will rise due to normal sun exposure. The use of a non-metal would run the risk of material failure due to surpassing their maximum operation temperatures shown in Figure XIII.A.1 within Appendix A. Common piping material's thermal conductivity is plotted versus the material's maximum temperature operation in Appendix A to show correlations. The weight of this part of the system is not considered since the tanks are thin walled vessels and the piping thickness is also thin.

A valve will be used to control the flow of the oil from the cold oil reservoir tank. The valve was selected based on operating temperatures. As the maximum temperature for most rubbers is around 400°F (204°C), a brass one was selected to ensure no failure would occur within the valve. The flange used in the reservoir tank and the copper pipe fittings, such as elbows and compression fittings, are all within operating temperature ranges. The rest of the subsystem, the support of the reservoir, the base and stand for the solar collector can all be made out of wood. There is very little rain in the desert of Rajasthan to cause worry of warping and wood is cheaper than using sheet metal to build the subsystem. This also allows for an easy construction and only the need for low tech tools. The other option for the stand would be to construct it out of clay, however the correct height will be difficult to achieve.

## **IX.ii Energy Storage**

The storage tank used in between the collection and the cook top has few parts but the material selection is important to the overall efficiency of the system. Poor insulation leads to the oil losing too much heat. The main drive behind burying the tank is underground is that sand is a good insulator, with a thermal conductivity of 0.15 - 0.25W/mK when it is dry and packed. The sand not only acts as an insulator but also, within four feet of the surface, will be at the average yearly temperature of 27°F. This will help the oil maintain its temperature over time.

The storage tank itself will have to be a metal tank due to the high temperatures of the stored oil. The oil temperature required is at least 200°C and there material cannot melt. The downfall of having to use metal as a tank is that the high thermal conductivity allows the heat to quickly be output, even if there is insulation. The same kind of tank will be used as with the cold oil reservoir, made of steel, with similar flange and compression fittings to allow for air pump input and oil output. This was chosen because the tanks are inexpensive compared to the other alternative, building a tank from scratch, and is easy to order online.

### **IX.iii Cooktop**

Thin copper tubing will be used to make the cooktop. This has been chosen because, similar for the collector use, copper has a high thermal conductivity and will allow maximum energy transfer from the oil to the cooking surface. Additionally, the thin tubing is malleable and can be formed to fit into the body of the stove. The body design material will be clay, a common material use in rural India, and has been used for stove building in the past. The clay allows for the form to be built by each woman making the height and width customizable to their ergonomics. It is also able to withstand high temperatures and help insulate the storage tank since it will be positioned above it.

Table IX.iii.1 displays the different components and materials that are to be used to build the solar cookstove stove as well as where they will be made and the tools needed for construction. The tanks and the fittings associated with them for piping of the system will originally be built within India and sent to Rajasthan. Ideally, once the technology is adopted the installation and maintenance crews will be trained to build the tanks with fittings themselves so that the villages will be self-sufficient, minus supplies, with respect to the stove. The collector shape is extremely important in the efficiency of the design, thus the wooden supports and outline for it will be pre-cut for the villagers. They will then need to apply the styrene sheet backing and affix the Mylar and acrylic strips themselves. The stand for the collector as well as the stove is possible to be built within Rajasthan. The piping, due to the variability of the homes, must be able to be adjusted thus pre-cut standard sized tubes will be sent and the installation crews can cut and attach needed fittings with a hand held battery powered soldering tool.

**Table IX.iii.1:** Breakdown of origin of materials of the SolAr system.

<b>Material/Component</b>	<b>Here/There?</b>	<b>Tools Needed (In Rajasthan)</b>
Cold and Hot storage Tanks With Fittings	Built and sent from India	Shovel and wood for cold storage tank stand
Collector Shape	Cut and sent from India	None
Reflector: Mylar and Acrylic	Cut and sent from India	For application: Need polystyrene for collector surface, epoxy for application of Mylar and Acrylic panels
Solar collector stand	There	Saw & nails/screws
Piping for system	Piping in India	Expected to be Cut and soldered there. Portable Soldering iron will be sent.
Stovetop and Oven	Piping in India. Clay found there	Clay stoves can be built there individually, copper tubing to be installed by someone else.
Installation and Maintenance	There	Tools and Education provided for team of villagers on an Installation and maintenance crew.

Table IX.iii.2 displays the bill of materials for the entire stove. Approximated pipe lengths have been assumed to complete the cost analysis however the lengths and fittings may vary based on the home size and dimensions. The cost of the final product was more than double of the budget allotted, finalized at \$502.09. However, the gains for the women who will use it

greatly outweigh the cost. The women will have time to participate in income producing activities such as farming and tending to livestock. Their children will be able to go to school and will also grow up in a household that supports protecting the environment and a sustainable lifestyle. They will gain not only more time, but a longer healthier life without smoke induced respiratory issues. On top of the users, others in the village who will work as maintenance and installation crews will gain the experience of having an extremely important job of helping their fellow villagers learn about alternative energy. They will be responsible for being the front men of the product, educating people on how to use their stoves as well as provide the free maintenance that will act as an incentive for users. While the cost is greater than desired, the eventual benefits from a sustainable system outweigh the initial monetary cost. [22, 68-78]

**Table IX.iii.2:** Material cost breakdown of the entire system

Item	Description	Unit Cost (\$)	Qty.	Total Cost (\$)	Here/There	References
UN-Compliant Steel Pail (Open Pail + Lid)	Cold and Hot storage tanks	\$13.69	2	\$27.38	Here	[68]
Copper 90° Tube Fitting	Tube fitting for installation	\$1.12	5	\$5.60	Here	[22]
Anderson Fittings 421359 1/2 5/16 Comp X 1/4 Comp Union	Compression Fittings on Tanks	\$3.00	2	\$6.00	Here	[69]
World 27-3/4G 3/4 Galv Malbl Floor Flange	Pipe fitting (Flange) on Tanks	\$2.00	2	\$4.00	Here	[70]
Owens Corning R-6.7 Unfaced 2 in. x 16 in. x 48 in. Multi Purpose Continuous Roll Insulation	Insulation for collector olive oil heating pipe	\$3.94	2	\$7.88	Here	[71]
Plywood				\$0.00	There	
Olive Oil (13 gallons)	Energy Storage Material	\$20.40	13	\$265.20	There	[72]
Cooper Tools Cordless Soldering Iron, Battery-Powered	Soldering Iron for tube fittings	\$19.99	1	\$19.99	There	[73]
Solder-Joint Copper Tube Fitting for Water, Union, Socket (Female) X Socket (Female) for 3/4" Tube Size	Unions for ease of installation and maintenance	\$5.52	3.00	\$16.56	There	[70]
Mylar Sheeting (1.2m <sup>2</sup> )	Reflective backing of solar collector	\$1.66	1.2	\$1.99	Here	[74]
Mirrored Acrylic (1.2m <sup>2</sup> )	Reflective Strips for solar collector	\$67.81	1.2	\$81.37	Here	[75]
Copper Pipe (Est)	Piping system for olive oil	\$1.70	12	\$20.40	There	[70]
Permatex High-Temperature RTV Silicone Gasket Maker, 3-Ounce Tube	Sealant Silicone used on Storage Tanks (high temp)	\$6.41	2	\$12.82	Here	[76]
Heavy Duty Metal Drum Pump Zinc-Plated STL, 22 oz/Stroke, 35-1/4" L Intake Tube	Stovetop and storage tank pump	\$29.51	1	\$29.51	Here	[77]
020" Thick High Impact Styrene Sheet 40" X 72"	Styrene Sheet	\$3.39	1	\$3.39	Here	[78]
Clay	Stove Base Material	0		\$0.00	There	
<b>Total</b>				<b>\$502.09</b>		

## X. Realizations and Deployment

The design of the system centered mostly on the success of meeting all of the engineering design requirements. The customer requirements put multiple constraints on the design and had more impact on material selection and



ergonomic factors. The current solar stove design is, at its current state, not able to be deployed into rural Rajasthan. Reasons and future corrections follow, as well as deployment methods for the future when the system is complete.

One future development is addressing the challenge of constructing the system in Rajasthan. The largest being that construction must involve proper installation of piping and fittings. The piping of the system can be difficult if directions are not followed properly and due to the high temperatures of the oil it is imperative that directions are followed correctly for the user's safety. Crews of installation and maintenance workers, hired by the sponsors of the stove, will be trained. This aspect of the project has not been addressed yet but will need to be for deployment. A culturally appropriate instruction manual on installation as well as classes on the tools, trades and maintenance troubleshooting need to be developed for proper use and deployment.

Another aspect that still must be refined is the pump for the output and stovetop. Ideally, the flow rate controls the temperature the stove top reaches and how quickly. The current design however does not address how this will be monitored or adjusted by the user. A more automated or controllable pump must be attached for the temperature control to be accurate. This will also help increase the safety of the system.

Since the solar collector mirrors must be perfectly aligned, as well as the Zenith and Azimuth angles properly measured and set for successful heating of the oil, plans for a more precise construction and an automated angle correction need to be developed. This is one of the only ways to avoid a photovoltaic unit. Unfortunately this could add a lot of extraneous cost to the design but without, at minimum, a more efficient way to set the angles the solar stove will be rendered useless. More streamlined pumping and deployment of the oil would also help efficiency, however would need to be done with cost kept in mind as well as construction for each home.

Although the solar cookstove will provide women in rural Rajasthan with more time, better health, and a more profitable future, successful deployment can still be stunted. The main reasons will be culturally and habit based. If the villagers are not educated properly on the technology and the reasons behind a new stove design, they will not see the need to adopt it, making deployment a failure.

Collecting wood for cooking is currently free to these women and although it takes hours of their day to gather and the smoke from cooking causes them health issues, the collection process has been part of their daily routine for so long that it has become a cultural aspect as well. The need to overcome the idea that wood is “free” must occur. It must be seen as a cost to them, not only to their health but to their environment as well. If this education is not completed or accepted, deployment of the stove will be a difficult task.

Deployment will also rely on the successfulness of creating installation and maintenance crews made of local villagers that are willing to work for the sponsors involved. It is assumed by some that those in poverty desire to work to escape it. The sponsors of this project however have informed us that most men in rural Rajasthan during the day do not do much work to support their families. These maintenance and installation crews will be the frontline of the project. The people who make up the groups will be the initial voice and link between the sponsors and the village women therefore their enthusiasm, or possible lack thereof, will set the tone of the deployment.

Lastly, education on building a sustainable lifestyle must be brought to the people of the villages. The best way to foster the growth of the overarching goals of this project, stop deforestation, break the poverty cycle, decrease health issues within the families, is to educate the children who will grow to support their own families. Team Sol^R believes that if this cultural habit of children not going to school to help support their mothers is not broken that the

solar cookstove will not have a successful deployment in the future, thus not becoming a self sustaining system.

## XI. Conclusion

In Rajasthan, dependence on wood burning for cooking has become rampant and this takes a toll on the forest vegetation of the land. Smoke related diseases and illiteracy among women and children which directly stems from the dependence on the land cannot be ignored. The energy from the sun, an abundant energy in the Rajasthan desert, has led to the idea to build a solar powered stove, thus replacing wood burning stoves. The need for an alternative way of cooking becomes obvious, for the current status quo is no longer sustainable. The problem statement has a myriad of challenges woven all around it due to the high level of constraints from the engineering and cultural standpoint. However, with the help of research, design tools, analysis and testing, the design was brought to completion. The solar cook stove solution presented in this report consists of a parabolic solar collector which is being used to heat olive oil and then stored once the desired temperature is achieved in an insulated tank. Then a pump controls the output, in the form of a stovetop, where the hot oil transfers its energy into heat so the user can cook. The used oil is then cycled and used the next day in the same process.

For the design to be successful and have the desired impact, certain cultural modifications were necessary. User benefit analysis and product marketing at all levels was required to ensure proper design development and deployment into rural Rajasthan. This was key, after the past designs implementation by teams such as the Iowa and Berkley groups. This project has avoided the pitfalls faced by previous attempts by providing a design that is tested, prototyped and retested to guarantee the most reliable and feasible result. The design process should still continue, and additions to the system made to ensure the highest efficiency and safety to the users.

This solar stove product will not only add real benefits to the life of the indigenous people of Rajasthan, but it will further enable these people to be more productive. The successful deployment however will not occur without a

fight; the local women are plagued with the dilemma of having to choose whether to pay money for doctor's visits or pay money to buy the solar cook stove. A tough choice when considering wood is free to them. Children are missing out on important areas of their lives, such as education because most of their time is spent helping their mothers bring food to the table. Deforestation is also taking toll on the lives of these people as well as their live stock which are finding it hard to locate good grazing land. Therefore, with little effort, it is easy to connect the dots as to weighing between the benefit of having a solar cook stove or continuing with the status quo. Now all that is needed is an effective deployment method that is culturally sensitive and allows or the villages to become self-sufficient and have a sustainable lifestyle. This will happen through education and the villages coming together to help save their women and children, as well as their environment.

## XII. References

- [1] S. K. J. P. V. Laxmi, P. Dabrase, "Household energy, women's hardship and health impacts, in rural Rajasthan, India: need for sustainable energy solutions," *Energy for Sustainable Development*, vol. VII, pp. 50-67, 2003.
- [2] (September 20, 2011). *Solar Irradiation/Insolation in Mewar, Rajasthan, India*. Available: [http://www.synergyenviron.com/tools/solar\\_insolation.asp?loc=mewar%2C%20rajasthan%2C%20india](http://www.synergyenviron.com/tools/solar_insolation.asp?loc=mewar%2C%20rajasthan%2C%20india)
- [3] (September 20, 2011). *30/60° solar oven - Solar Cooking*. Available: [http://solarcooking.wikia.com/wiki/30/60%C2%B0\\_solar\\_oven](http://solarcooking.wikia.com/wiki/30/60%C2%B0_solar_oven)
- [4] *Solar Oven: Discover the taste of sun*. Available: <http://www.sunoven.com/>
- [5] Bailey, "Solar thermal collector cabinet and system for heating storage," 2009.
- [6] E. Borgens, "Solar Oven," 1992.
- [7] Brugger, "Solar heat storage systems," 1980.
- [8] Carlson, "Solar heat storage systems," 1977.
- [9] W. Chiles, "Solar cooker," 1981.
- [10] Christ, "Latent heat storage devices," 2007.
- [11] Huchins, "Latent-heat heating and cooling system," 1984.
- [12] Inagaki, "Solar cooker assembly," 1990.
- [13] Kalkanoglu, "Coating composition for roofing granules, dark colored roofing granules with increased solar heat-reflective shingles, and process for producing the same," 2011.
- [14] G. Lof, "Solar Cooker," 1959.
- [15] Pause, "Textile heat accumulator for utilization of solar energy," 2006.
- [16] Persiani, "Heat absorbing surface coating," 2001.
- [17] Zhang, "Light-Heat Energy Gathering Solar Energy Device," 2009.

- [18] (September 20, 2011). *Auroville Solar Bowl - Solar Cooking*. Available: [http://solarcooking.wikia.com/wiki/Auroville\\_Solar\\_Bowl](http://solarcooking.wikia.com/wiki/Auroville_Solar_Bowl)
- [19] (September 20, 2011). *Scheffler Community Kitchen*. Available: [http://solarcooking.wikia.com/wiki/Scheffler\\_Community\\_Kitchen](http://solarcooking.wikia.com/wiki/Scheffler_Community_Kitchen)
- [20] G. F.-S. Bart Orlando, Ana Kolpin. *Parabolic basket and tin can solar cooker*. Available: [http://www.cd3wd.com/cd3wd\\_40/ap/Parabolic\\_basket\\_and\\_tin\\_can\\_solar\\_cooker.html](http://www.cd3wd.com/cd3wd_40/ap/Parabolic_basket_and_tin_can_solar_cooker.html)
- [21] (2007). *Positive Displacement Pump: A guide to performance evaluation*. 1st.
- [22] *Copper Pipe Fittings*. Available: <http://www.mcmaster.com/#copper-pipe-fittings/=f60z7v>
- [23] McMaster-Carr. (November 21, 2011). *Hand Operated Diaphragm Pump*. Available: <http://www.mcmaster.com/#diaphragm-hand-pumps/=f1a3yj>
- [24] H. Pneumatics. (November 21, 2011). *Hydraulic Pumps - Part 1*. Available: <http://www.hydraulicspneumatics.com/200/FPE/Pumps/Article/True/6401/Pumps>
- [25] Red-Bag. (November 21, 2011). *BN-DG-C01K Plant Layout - Pumps*. Available: <http://www.red-bag.com/jcms/design-guides/354-bn-dg-c01k-plant-layout-pumps.html>
- [26] F. C. D. Repository. (November 21, 2011). *3.6 Rotary Positive Displacement Pum*. Available: <http://www.fao.org/docrep/010/ah810e/AH810E06.htm>
- [27] A. Education. (November 21, 2011). *Topic 3 First Law of Thermodynamics*. Available: [http://www.antonine-education.co.uk/physics\\_a2/options/module\\_7/topic\\_3/topic\\_3\\_first\\_law\\_of\\_the\\_rmodynam.htm](http://www.antonine-education.co.uk/physics_a2/options/module_7/topic_3/topic_3_first_law_of_the_rmodynam.htm)
- [28] D. McIntosh. (October 1, 2010, November 22, 2011). *Cleaner, safer living through improved cookstoves*. Available: <http://www.mercycorps.org/dorymcintosh/blog/22244>

- [29] "Project Update 8/10," Climate Healers August 24, 2011.
- [30] L. A. Adam Rausch, Ailey Crow, Dylan Saloner, "Stored Energy Solar Cookstove for Rajasthan, India," Mechanical Engineering Department at the University of California, Berkeley May 13, 2011.
- [31] e. a. Scott Ruebush, "The Hawkey Solar Cooker," Mechanical Engineering Department at The University of Iowa June 25, 2011.
- [32] S. Rao, C. C. Ivan Tibivinsky, Phyllis Petronello, Caitlin Chapin, Ed., ed, September, 2011.
- [33] A. R. Srilatha Batwila, ""Energy for women and women for energy (engendering energy and empowering women)," " *Energy for Sustainable Development*, vol. 2003, pp. 33-43, 2003.
- [34] S. S. S. Gulati. Population pressure and deforestation in India.
- [35] S. Batliwala, Reddy, A., "Energy for women and women for energy (engendering energy and empowering women)," *Energy for Sustainable Development*, vol. VII, 2003.
- [36] (2010, Global Forest Resources Assessment and the State of the World's Forests.
- [37] A. D. Ahhijit Banerjee, Esther Duflo, "Health, Health Care, and Economic Development: Wealth, Health, and Health Services in Rural Rajasthan," *American Economic Review*, vol. 94, pp. 326-330, 2004.
- [38] (2008, September 20, 2011). *New global poverty estimates - What it means for India*. Available:  
<http://www.worldbank.org.in/WBSITE/EXTERNAL/COUNTRIES/SOUTHASIAEXT/INDIAEXTN/0,,contentMDK:21880725~pagePK:141137~piPK:141127~theSitePK:295584,00.html>
- [39] K. Jammu, "Evaluation Report on Swarnjanti Gram Swarozgar Yojana," Department of Economics at University of Kashmir, Government of India, New Delhi 2009.
- [40] *Popular Schemes*. Available: <http://gov.bih.nic.in/Schemes.htm>



- [41] O. Twidell, Weir, A., D., *Renewable Energy Resources*: Spon Press, 2006.
- [42] U. o. Strathclyde. *Sun Chart Examples*. Available:  
[http://www.esru.strath.ac.uk/Courseware/Design\\_tools/Sun\\_chart/example.htm](http://www.esru.strath.ac.uk/Courseware/Design_tools/Sun_chart/example.htm)
- [43] U. o. O. R. M. Laboratory. (2007). *Sun Path Chart Program*. Available:  
<http://solardat.uoregon.edu/SunChartProgram.html>
- [44] F. Incropera, P., Dewitt, D., P., Bergman, T. L., Adrienne, S. L., *Fundamentals of heat and mass transfer*, 6th ed.: John Wiley & Sons, Inc., 2007.
- [45] (September 20, 2011). *What is Direct Normal Irradiance?* Available:  
<http://www.3tier.com/en/support/solar-prospecting-tools/what-direct-normal-irradiance-solar-prospecting/>
- [46] H. Nouredini, Teoh, B., C., Clements, L., D., "Densities of vegetable oils and fatty acids," *Chemical and Biomolecular Engineering Research and Publications*, vol. 69, pp. 1184-1192, 1992.
- [47] (1996, November 10, 2011). *Latitude-Longitude of US Cities*. Available:  
<http://www.realestate3d.com/gps/latlong.htm>
- [48] (2011, October 31, 2011). *Solar Insolation*. Available:  
[http://www.synergyenviron.com/tools/solar\\_insolation.asp?loc=Atlanta%2C%20Georgia%2C%20United%20States](http://www.synergyenviron.com/tools/solar_insolation.asp?loc=Atlanta%2C%20Georgia%2C%20United%20States)
- [49] J. Colton. (2011, October 20, 2011).  *Casting Analysis 1*. Available:  
<http://www.me.gatech.edu/jonathan.colton/me4210/castanal1.pdf>
- [50] T. E. T. Box. *Liquids and Fluids Specific Heats*. Available:  
[http://www.engineeringtoolbox.com/specific-heat-fluids-d\\_151.html](http://www.engineeringtoolbox.com/specific-heat-fluids-d_151.html)
- [51] R. Munson, R., Young, D., F., Okiishi, T., H., Huebsch, W., W., *Fundamentals of fluid mechanics*: John Wiley & Sons, Inc., 2009.
- [52] E. Rehfuss, "Fuel for life paper: Household energy and health," *World Health Organization*, 2006.
- [53] (1997). *Does cooking oil evaporate?* Available:  
<http://www.oliveoilsource.com/asktheexpert/does-cooking-oil-evaporate>

- [54] D. Enger. (2006). *My Pipeline's Corroded: But I thought oil prevented rust*. Available:  
[http://www.slate.com/articles/news\\_and\\_politics/explainer/2006/08/my\\_pipeline\\_corroded.html](http://www.slate.com/articles/news_and_politics/explainer/2006/08/my_pipeline_corroded.html)
- [55] J. Harrison, "Investigation of Reflective Materials for the Solar Cooker," Florida Solar Energy Center 2001.
- [56] W. T. Plummer. (1995). *A new optical illusion? Everyday optics*.
- [57] (2011, November 30, 2011). *Polyester Film 48 inch x 50 ft*. Available:  
<http://www.hydroponics.net/i/133014>
- [58] (November 30, 2011). *Reynolds Wrap Aluminum Foil*. Available:  
[http://www.walmart.com/ip/Reynolds-Wrap-Aluminum-Foil-Aluminum-Foil-200-sf/11027096?ci\\_sku=11027096&ci\\_src=14110944&sourceid=1500000000000007346530](http://www.walmart.com/ip/Reynolds-Wrap-Aluminum-Foil-Aluminum-Foil-200-sf/11027096?ci_sku=11027096&ci_src=14110944&sourceid=1500000000000007346530)
- [59] (November 30, 2011). *36in x 48 Acrylic Mirror 5-Sheet Contractor Value Pack*. Available: <http://www.homedepot.com/buy/building-materials-plexiglass/36-in-x-48-in-acrylic-mirror-5-sheet-contractor-value-pack-118780.html>
- [60] (November 30, 2011). *Frameless Glass Mirror*. Available:  
[http://www.google.com/products/catalog?hl=en&client=firefox-a&rls=org.mozilla:en-US:official&q=glass+mirror&gs\\_upl=131429132759111133883121210101010171124611.11210&bav=on.2,or.r\\_gc.r\\_pw.r\\_cp.,cf.osb&biw=1095&bih=905&um=1&ie=UTF-8&tbm=shop&cid=356362745376100634&sa=X&ei=YnWTu7JDYKTtwegr2dCA&ved=0CKQBEPICMAE](http://www.google.com/products/catalog?hl=en&client=firefox-a&rls=org.mozilla:en-US:official&q=glass+mirror&gs_upl=131429132759111133883121210101010171124611.11210&bav=on.2,or.r_gc.r_pw.r_cp.,cf.osb&biw=1095&bih=905&um=1&ie=UTF-8&tbm=shop&cid=356362745376100634&sa=X&ei=YnWTu7JDYKTtwegr2dCA&ved=0CKQBEPICMAE)
- [61] *Astro-Foil Reflective Insulation 2'x125'*. Available:  
<http://www.advancedgreenergysolutions.com/store/3665606/product/4030.06?www.advancedgreenergysolutions.com>
- [62] M. G. W. Carroll, C. Godwin, M. Kim, C. Miller, R. Parrish, E. Woods, J. Colton, and S. Khan, "Nicaragua: ME4182G final report," Georgia Institute of Technology April, 2010.

- [63] *Thermal Conductivity of Metals*. Available:  
[http://www.engineeringtoolbox.com/thermal-conductivity-metals-d\\_858.html](http://www.engineeringtoolbox.com/thermal-conductivity-metals-d_858.html)
- [64] *Thermal Conductivity of some common Materials and Gases*. Available:  
[http://www.engineeringtoolbox.com/thermal-conductivity-d\\_429.html](http://www.engineeringtoolbox.com/thermal-conductivity-d_429.html)
- [65] (November 30, 2011). *Metal - Melting Temperatures*. Available:  
[http://www.engineeringtoolbox.com/melting-temperature-metals-d\\_860.html](http://www.engineeringtoolbox.com/melting-temperature-metals-d_860.html)
- [66] *Polymers*. Available:  
<http://www2.chemistry.msu.edu/faculty/reusch/VirtTxtJml/polymers.htm>
- [67] (2006, November 30, 2011). *CPVC Chlorinated Polyvinyl Chloride*. Available: <http://www.indianplasticportal.com/cpvc.html>
- [68] *Steel and Stainles Steel Pails*. Available:  
<http://www.mcmaster.com/#steel-pails/=f6vsfn>
- [69] *Compression Union (AB62A-54)*. Available:  
<http://www.amazon.com/Anderson-Copper-Brass-AB62A-54-Compression/dp/B000KLSDQ2>
- [70] *Galvanized Floor flange, 3/4"*. Available:  
<http://www.amazon.com/Galvanized-Floor-Flange-3-4/dp/B000UVL9EA>
- [71] *Owens Corning R-6.7 Unfaced 2 in. x 16 in. x 48 in. Multi Purpose Continuous Roll Insulation*. Available:  
<http://www.homedepot.com/buy/building-materials-insulation-fiberglass/owens-corning-r-6-7-unfaced-2-in-x-16-in-x-48-in-multi-purpose-continuous-roll-insulation-182018.html>
- [72] *Olive Pomace Oil 1 Gallon*. Available:  
[http://www.webstaurantstore.com/olive-pomace-oil-1-gallon/101OLIVEPOM%201G.html?utm\\_source=Google&utm\\_medium=cse&utm\\_campaign=GoogleShopping](http://www.webstaurantstore.com/olive-pomace-oil-1-gallon/101OLIVEPOM%201G.html?utm_source=Google&utm_medium=cse&utm_campaign=GoogleShopping)
- [73] *Cooper Tools Cordless Soldering Iron, Battery-Powered* Available:  
[http://www.sears.com/shc/s/p\\_10153\\_12605\\_00954080000P?sid=IDx20070921x00003a&ci\\_src=14110944&ci\\_sku=00954080000](http://www.sears.com/shc/s/p_10153_12605_00954080000P?sid=IDx20070921x00003a&ci_src=14110944&ci_sku=00954080000)

- [74] *Reflective Mylar 2 Mil 48in x 50ft*. Available:  
<http://www.amazon.com/Reflective-Mylar-Mil-48in-50ft/dp/B0032JWR1Q>
- [75] *36 in. x 48 in. Acrylic Mirror 5-Sheet Contractor Value Pack*. Available:  
<http://www.homedepot.com/buy/building-materials-plexiglass/36-in-x-48-in-acrylic-mirror-5-sheet-contractor-value-pack-118780.html>
- [76] *Silicone Adhesive/Sealant*. Available:  
<http://www.mcmaster.com/#potting-silicone/=f617kg>
- [77] *Heavy Duty Metal Drum Pump*. Available:  
<http://www.mcmaster.com/#drum-hand-pumps/=f6w0wa>
- [78] *.020" Thick High Impact Styrene Sheet 40" X 72"*. Available:  
<http://www.usplastic.com/catalog/item.aspx?itemid=28982>
- [79] J. H. A. Kearney, M. Verdonck, H. Derveaux, L. Dumarest. (2010, September 20, 2011). *Unlocking the Sunbelt: Potential of Photovoltaics*.

## XIII. Appendices

### A. Selection criteria tools (path)

For the design selection a morph chart was completed and is shown in Table XIII.A.1. The morph chart is divided into the main engineering functions to create design ideas for the three subsystems: collection, storage and output (the stove top). The various design ideas are separated by the mechanism for which they are categorized, such as chemical reactions or mechanical processes for example.

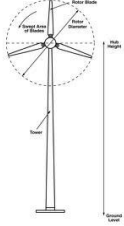
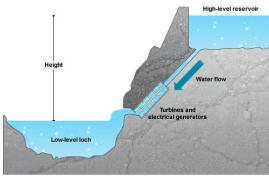
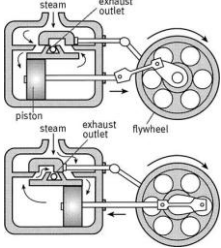
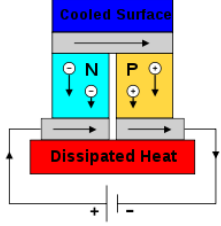
**Table XIII.A.1:** Morph Charts for subsystem design brainstorming

	<b>Mechanical</b>	<b>Mechanical</b>	<b>Mechanical</b>	<b>Electrical</b>	<b>Electric/Thermal Combination</b>	<b>Chemical</b>	<b>Chemical</b>	<b>Thermal</b>	<b>Thermal</b>	<b>Thermal</b>
<b>Collect energy</b>	Energy Harvesters	Wind Energy	Hydroelectric Energy Collection	Photovoltaics	Peltier Thermal Electric Effect	Algae	Steam Energy Creation from solar power	Geothermal	Reflective Materials	Refractive Materials
	<b>Mechanical</b>	<b>Mechanical</b>	<b>Mechanical</b>	<b>Mechanical</b>	<b>Electrical</b>	<b>Electric/Thermal Combination</b>	<b>Chemical</b>	<b>Chemical</b>	<b>Chemical</b>	<b>Thermal</b>
<b>Store energy</b>	Lift object into air (PE)	Spring loading (PE)	Compressed Air	Rolling Mass	Battery Storage	Grid Storage (previously installed)	Form gas/form fuel for burning	Phase Change Materials (storage)	Vacuum Tube	Insulation
	<b>Mechanical</b>	<b>Mechanical</b>	<b>Electrical</b>	<b>Electric/Thermal Combination</b>	<b>Chemical</b>	<b>Chemical</b>	<b>Chemical</b>	<b>Thermal</b>	<b>Thermal</b>	<b>Thermal</b>
<b>Deliver Energy</b>	Friction heat release	Steam Turbine	Electrical Resistance	Induction energy/heat	Exothermic Reaction	Phase Change Materials (release)	combustion	radiation	convection	conduction

For collection of energy a few design ideas were discounted after initial research, mostly based on cost. Energy harvesters, which absorb vibrational energy and store electricity, are too expensive and not applicable enough to the design task at hand. The use of algae as a biomass was discussed as a

material that could be grown, dried, and then burned as firewood is burned. This however would be difficult for the area because it is a desert and the amount of algae needed would not be able to support a family cooking needs from day to day. Geothermal energy was also discussed but then discounted because it would be invasive to the land as well as difficult to develop while still allowing every family to have their own stove. Before the team moved onto the idea of reflection, refraction or photovoltaics for solar collection, creating electricity for storage somehow was the initial path. A selection matrix was created, shown in Table XIII.A.2 for the four ideas left that would create electricity without solar energy. These included: wind power, hydroelectric power, steam generation and Peltier devices. Wind harvesters are poorly applicable based on the weather of Rajasthan and steam turbines to create the necessary power for the stove would require too large of a volume of steam to be practical. The peltier devices, which create electricity based on a temperature difference between the two sides (microvolts per degree), would be useful if multiple were not needed to create the proper amount of power needed for cooking. They also would be difficult to maintenance if they broke. Hydroelectric power was the most applicable choice for the design criteria however, after a discussion with the sponsors of this project, was decided impossible due to a major lack of water within the region of rural Rajasthan.

**Table XIII.A.2** Selection criteria converting heat to electricity

				
	Wind Energy Harvesters	Hydroelectric power	Steam to power generation (steam engine or turbine)	Peltier Device
Description				
Efficiency	2	2	3	3
Ease of use	4	4	3	3
Appropriate Technology	3	4	2	2
Reliability	4	4	3	3
Cost	2	3	5	3
Safety	4	4	3	4
Installation	2	2	2	3
Maintenance	2	3	1	1
<b>Total</b>	<b>23</b>	<b>26</b>	<b>22</b>	<b>22</b>

After hydroelectric power was excluded from the design for the collection subsystem, reflection, refraction and photovoltaics were compared [79]. These are the most common used mechanisms for basic solar collection. Photovoltaics are too expensive and are not appropriate technology for this project. The use of a large light refraction material, in essence using a large magnifying glass, is too expensive and fragile for this application. The winning design for the energy collection process was to use reflection devices, common solar collectors used for day-time use solar stoves, this is shown in Table XIII.A.3. An optimal parabola shape is necessary but the construction can be simple and the maintenance would be easy. These are just a few of the reasons that this collection process was chosen.


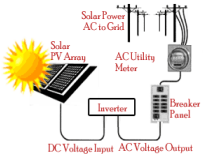

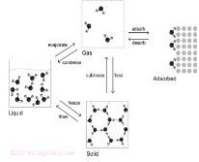
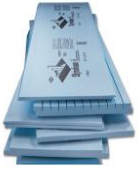
**Table XIII.A.3** Selection criteria for solar collection method

Criteria	Photovoltaic System	Reflective Material lined Collector	Refractive material
Description	Photovoltaic System	Reflective Material lined Collector	Refractive material
Price (low)	1	4	3
Maintenance (low)	1	4	4
Installation (ease)	1	4	3
Safety	3	4	2
Reliability	4	4	3
User interface	2	5	5
Appropriate Technology	1	4	3
<b>Total</b>	13	<b>29</b>	23

Energy storage options strongly depend on the collection method, however the design matrices were done in parallel to make sure the design process was not skipping over potential solutions. The most efficient forms of storage were selected to create the selection criteria matrix, including battery storage, a grid installation in Rajasthan, the forming of a gas or fuel, the use of a phase change material and the use of an insulated heat storage tank. This evaluation matrix is shown in **Table XIII.A.4**.



**Table XIII.A.4** Selection criteria for energy storage methods

					
Description	Battery Storage	Grid Installation	Forming of gas/fuel	Phase Change material	Insulated storage
Efficiency	3	4	4	3	2
Ease of use	3	1	2	3	5
Appropriate Technology	2	1	2	1	4
Reliability	3	2	3	2	3
Cost	3	1	2	1	5
Safety	3	3	1	2	5
Installation	4	1	4	3	4
Maintenance	2	1	3	3	4
<b>Total</b>	23	14	21	18	<b>32</b>

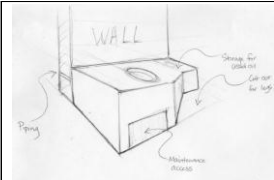
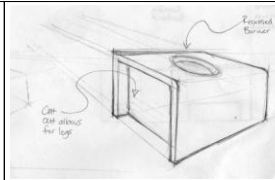
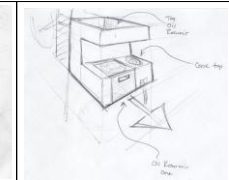
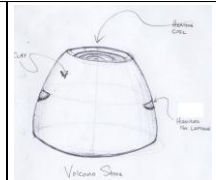
The forming of a grid is nearly impossible for the scope of this project, but would allow Rajasthani women to cook with electric stoves. A phase change material can be unstable and most importantly can be expensive. The forming of gas or fuel is a complicated process and could potentially be dangerous to the women who use the stove. Battery charging became a highly desired storage design however the creation of electricity was ruled out using the evaluation matrix shown in Table XIII.A.4. This leaves a simple, and low cost, insulated storage container for some form of energy transportation. This design leads to a simple solution that can be appropriate technology for the rural villages while still meeting the design constraints.

The first design created involved heating water to form steam, which would then be stored and used to heat a cooking unit at a later time. This was quickly dismissed due to the volume change from water to steam that would be required to store 4kW-hr worth of steam energy. The need remains then for a fluid with a high specific heat to carry the energy from the sun to the stovetop. After inspecting various liquids and judging their operating temperatures, evaporation points as well as corrosion aspects, olive oil was selected. It has a

specific heat of 1.97kJ/kgK, a smoke temperature (the temperature at which it evaporates at) of 260°C and is not corrosive to piping.

The design of the stovetop was driven by the need to extract as much energy as possible from the hot oil. The possibilities included a ceramic plate at the top of the storage tank which the oil could heat, a thin plate like vessel for the oil to flow into and create a stovetop or other shapes. For a higher efficiency and ease of construction both for prototype and for implementation, thin copper tubing was spiraled into the shape of a traditional electric stove top. The hot oil runs through the copper piping thus heating the surface. To maximize heat transfer, the bottom will be insulated so that heat only radiates upwards towards the cook top. Various designs for the stove output are shown in Table XIII.A.5

**Table XIII.A.5** Selection matrix for stove top design

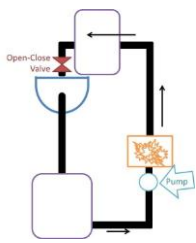
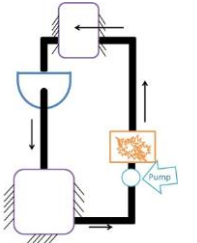
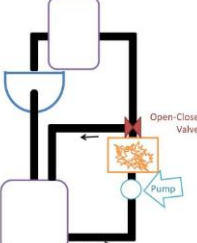
				
Description	Stove that holds all oil for cooking that can be pumped back out when used	cooktop with space for legs for women to sit close to the stove.	One burner wall unit that hides excess oil	Clay hand-made personalizable stove base
Efficiency	4	4	3	4
Ease of use	2	4	2	5
Appropriate Technology	3	4	2	5
Reliability	3	5	2	5
Cost	3	4	3	5
Safety	3	4	1	5
Installation	3	4	3	5
Maintenance	3	4	2	4
<b>Total</b>	24	33	18	<b>38</b>

In the first design, used oil is stored in the body of the tank and then pumped into the collector outside the next day for heating. The body is shaped to allow for the user to sit comfortably next to the stove and is built into the wall to keep it out of the way of the small houses found in rural villages. The second design has cut away space in the sides of the body that allow for the user to sit close to the burner while maximizing usable counter top space. It is a one burner stovetop which oil runs through for heating. In the third design used oil is stored in a removable container that can be dumped into a reservoir above. Does not

require pumping or carrying the oil completely out however exposes the user to dangerously hot oil. The last, and winning, design is a stand-alone ceramic stove that is easily manufactured and lightweight. Handles cut out of sides increase mobility. Recessed cook top increases cooking efficiency. It has the smallest footprint and can be made by the women of Rajasthan out of clay, making it customizable to their sitting height.

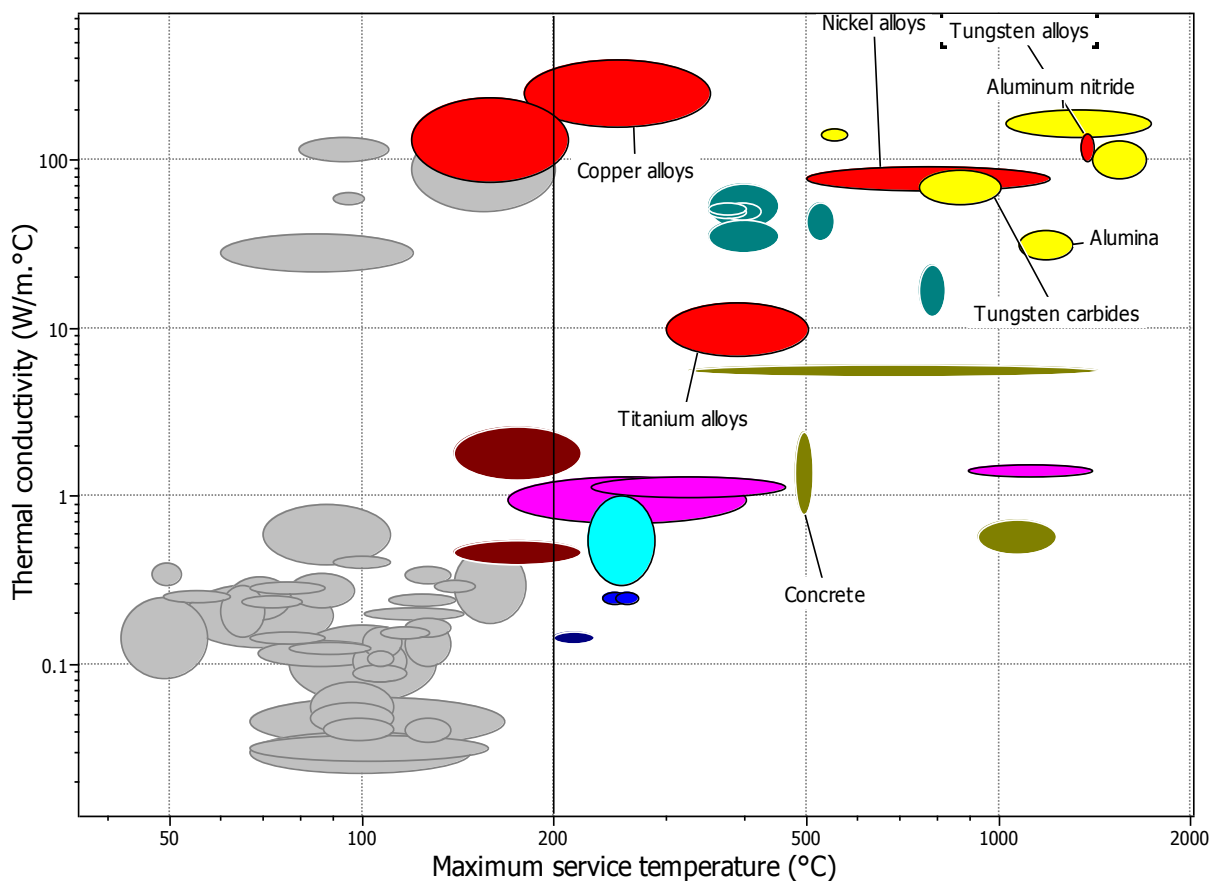
A few ideas were generated to configure the subsystems and circulate the oil. Table XIII.A.6 displays the top three designs with a closed system. An open system was dismissed because the user would need to empty the used oil into a separate tank and then carry it back to the cold oil reservoir for the next day. This leaves the user exposed to possible burns from the oil cooling down. The oil would also be exposed to the atmosphere for long periods of time where it could accumulate impurities that would clog the pipes. The closed system can be built into a non-circulating system, a circulating system with one loop and a two-loop system that allows the hot oil to transfer more heat with multiple cycles of the material with a shorter path.

**Table XIII.A.6** Selection matrix for circulating loops

Concept			
<b>Criteria</b>			
Description	Pumps up, but doesn't circulate multiple times	One loop, when pump circulates through whole system	Two loops, circulates oil multiple times, finally circulate to top reservoir
Efficient heat transfer	2	4	5
Simple Interface	3	5	3
Easy to construct	5	5	2
Appropriate technology	4	5	4
Reliability	4	5	3
Low cost	4	3	2
<b>Total</b>	<b>22</b>	<b>27</b>	<b>19</b>

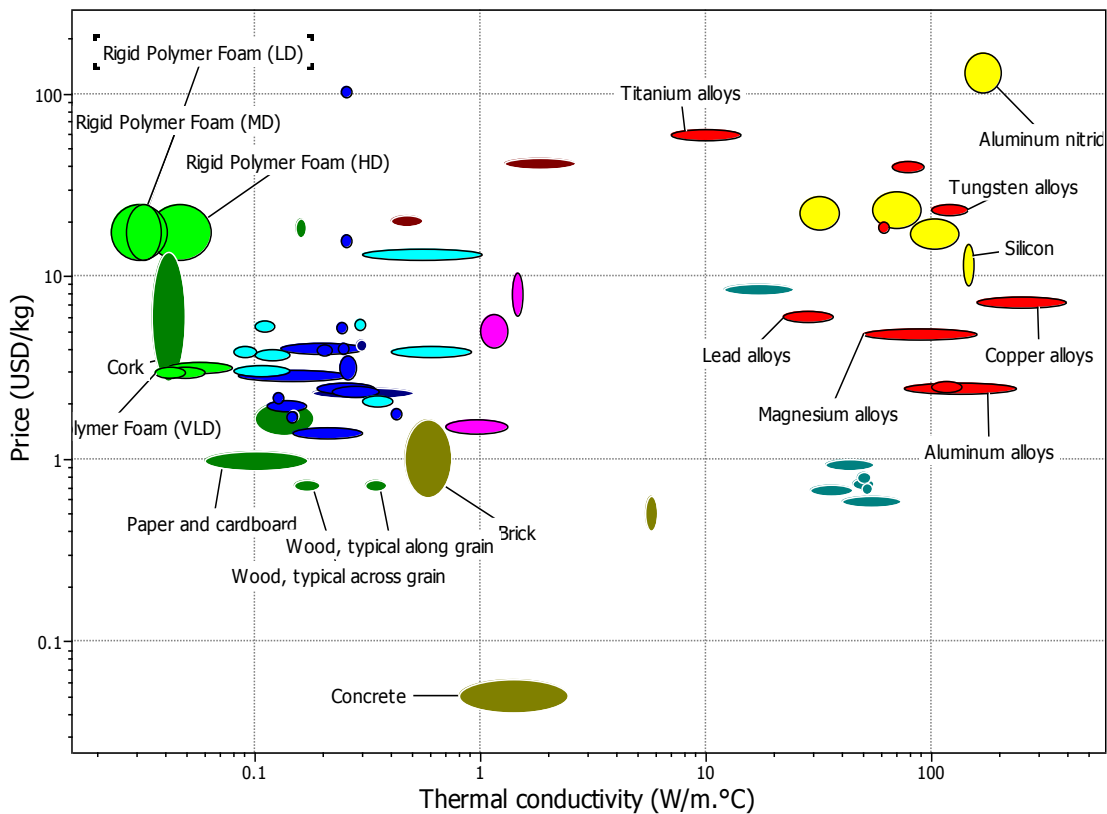
The system combination that best suits our constraints is one that is easy to use as well as easy to install. Although a two-loop system would allow a shorter path for the oil to circulate through the stovetop the design involves extra parts as well as a more complicated user interface. The non-circulating system does not allow for maximum energy extraction from the oil. The one loop system has the best outcome for a reliable and simple interfaced component, despite the fact that the efficiency is not maximized. A tradeoff is then made between maximum efficiency and user interface.

The last decision process discussed is material selection for the subsystems. This is discussed at length in Section X of the report. The supporting charts are shown below.



**Figure XIII.A.1** Thermal conductivity as a function of maximum temperature

Figure XIII.A.1 shows materials based on their thermal conductivity and maximum service temperature. When selecting materials for storage, output, and piping, this chart was consulted to verify that the material of components can withstand at least 200°C. The thermal conductivity was a large factor for insulation for the storage and fast heat transfer for the collector and stove top. Copper is shown mostly over the 200°C service temperature, and has an extremely high thermal conductivity, verifying the use as the piping for heated olive oil. Figure XIII.A.2 displays the cost of materials based on their thermal conductivity. Copper has the highest thermal conductivity on the chart, and is under 10\$/kg. The insulation materials for the storage tank and the backside of the solar collector were also chosen based on this chart.



**Figure XIII.A.2** Price as a function thermal conductivity

## B. Code

This section includes the codes used to mathmatically model the system. Engineering Equation Solver was used to anylze the model.

### B.i Collection Code

```
m_cont = 1 [kg]
m_cont = V_cont*density {Mass of the fluid being heated}
V_cont = PI*((D_cont/2)^2)*L_cont {Volume of the container of the fluid being heated}
D_cont = 0.05[m] {Diameter of the container of the fluid being heated. (Model assumes cylindrical shape)}
{L_cont= 10*D_cont} {Length of the container of the fluid being heated}
epsilon = 1 {Emissivity of the material of the object being heated}
alpha = 1 {Absorptivity of the object being heated}
rho = .95 {Reflectivity of the collector material or general efficiency of the collector}
density= 900 [kg/m^3] {Density of the working fluid}
c_p_wf = 1670 [J/kg*K] {Specific heat capacity of the fluid being heated (working fluid)}
T_avg = 313.5 [K] {Average temperature of Rajasthan}
A_collector = L_cont*4 {Surface area of the collector}
u_avg = 3 [m/s] {Average wind speed of Rajasthan}
t = 12 {Day time to be considered in hours}

A_cont = PI*D_cont*L_cont {Surface area of the container of the fluid being heated}

{Irradiance_may = 707*sin(PI*(time/3600)/13.53)
Irradiance_dec = 755*sin(Pi*(time/3600)/10.32)}

Irradiance = 5450/t {5.45 kWh/day*m^2}

Incoming_radiation = rho*alpha*Irradiance*A_collector
Outgoing_radiation = (A_cont*epsilon*sigma#*T_cont^4)

Power_radiation =Incoming_radiation - Outgoing_radiation

Call External_Flow_Sphere('Air', T_avg, T_cont, 101300 [Pa], u_avg , D_cont:
F_d\L_may, h, C_d_may, Nusselt_may, Re_may)
Power_convection = h*A_cont*(T_cont - T_avg)

m_cont*c_p_wf*T_dot_cont = Power_radiation - Power_convection

T_cont= T_avg +integral(T_dot_cont, time)
```

## B.ii Insulation Code

---

```
w = .15 [m] {Depth at which tank is buried}
L=0.07 [m]
V=0.000269
V=PI*D^2*L
{D = .5[m] Diameter of storage tank (assuming cylindrical shape)}
k_sand = 0.05 [W/m*K] {Thermal conductivity of sand}
k_ins = 0.05[W/m*K] {Thermal conductivity of insulating material}
m = (4/3)*PI*((D/2)^3)*1000 {Mass of stored working fluid (Volume*density)}
c_p = 2020 [J/kg*K] {Specific heat capacity of working fluid}
T_avg = 313.5 [K] {Avarage temperature of Rajasthan}
T_hot = 340 [K] {Maximum temperature of the fluid}
D_2=D+.348

SF=SF_2(D,w,L)

q_sand = SF*k_sand*(T_s_sand - T_avg) {Heat transfer assuming tank is
buried in sand}

{q_ins = k_ins*(4*PI*(D/2)^2)*(T_s_ins - T_avg)/.1 ".1 is the thickness of
the insulator" {Heat Transfer assuming tank is insulated}}

Call External_Flow_Cylinder('Air', T_avg, T_s_conv,101300 [Pa], .1 [m/s], D:
F_d, h, C_d, Nusselt, Re)
q_conv = h*(4*PI*(D/2)^2)*(T_s_conv-T_avg) {Heat transfer assuming tank is
not insulated}

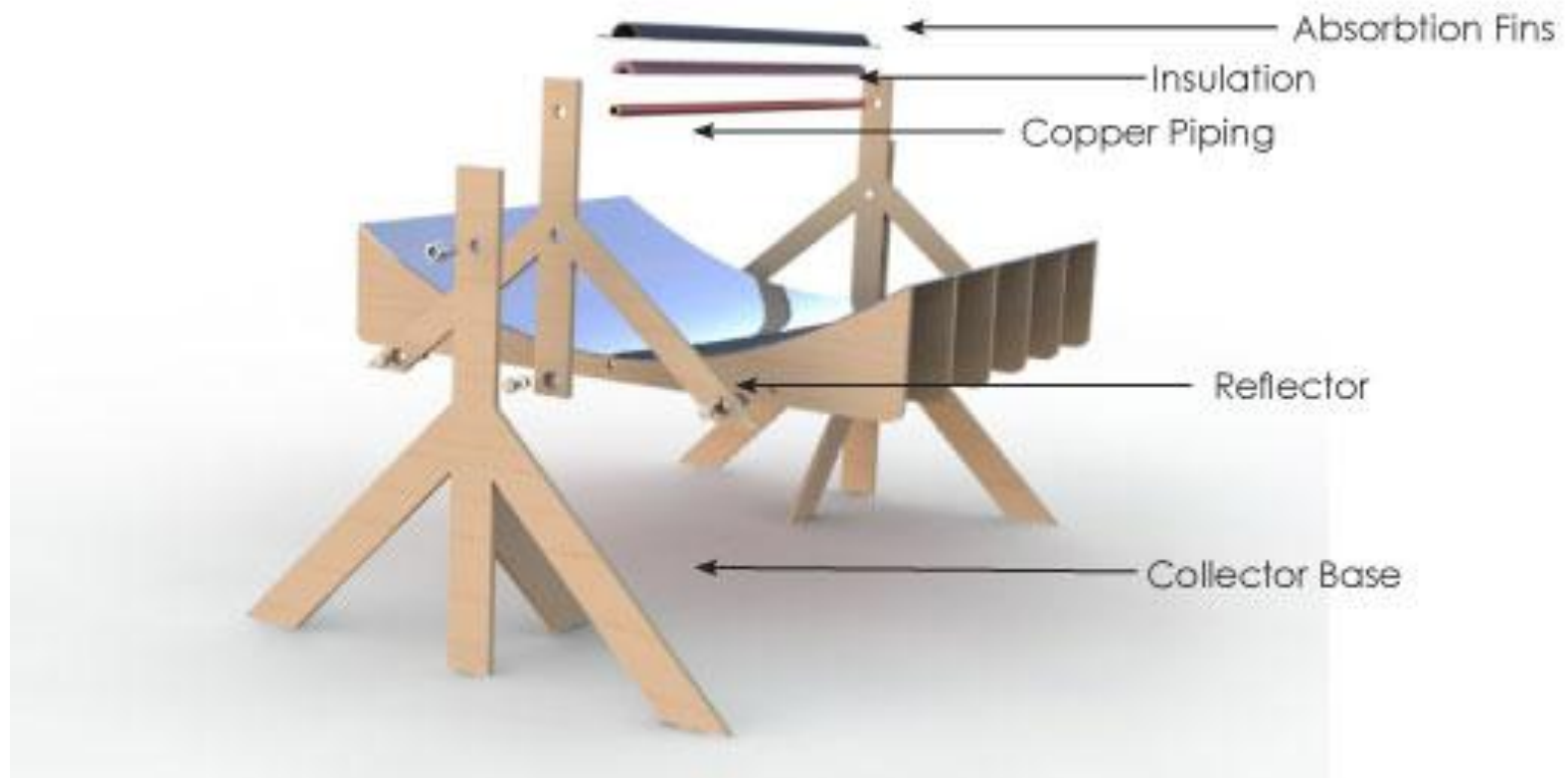
{Infinite Insulated Model}
R=(1/(h*PI*L*D))+ln(D_2/D)/(2*pi*k_ins*L)
q_inf_ins = (T_s_ins-T_avg)/R

m*c_p*T_dot_s_sand = -q_sand
{m*c_p*T_dot_s_ins = -q_ins}
m*c_p*T_dot_s_conv = -q_conv
m*c_p*T_dot_s_ins=-q_inf_ins
```

```
T_s_sand = 340 [K] +integral(T_dot_s_sand, time)
T_s_conv= 340 [K] +integral(T_dot_s_conv, time)
T_s_ins=340 [K]+integral(T_dot_s_ins,time)
```



## C. Additional System Images



**Figure C.1** Exploded View of the collector



**Figure C.2** Exploded view of a storage bucket to show flange attachment

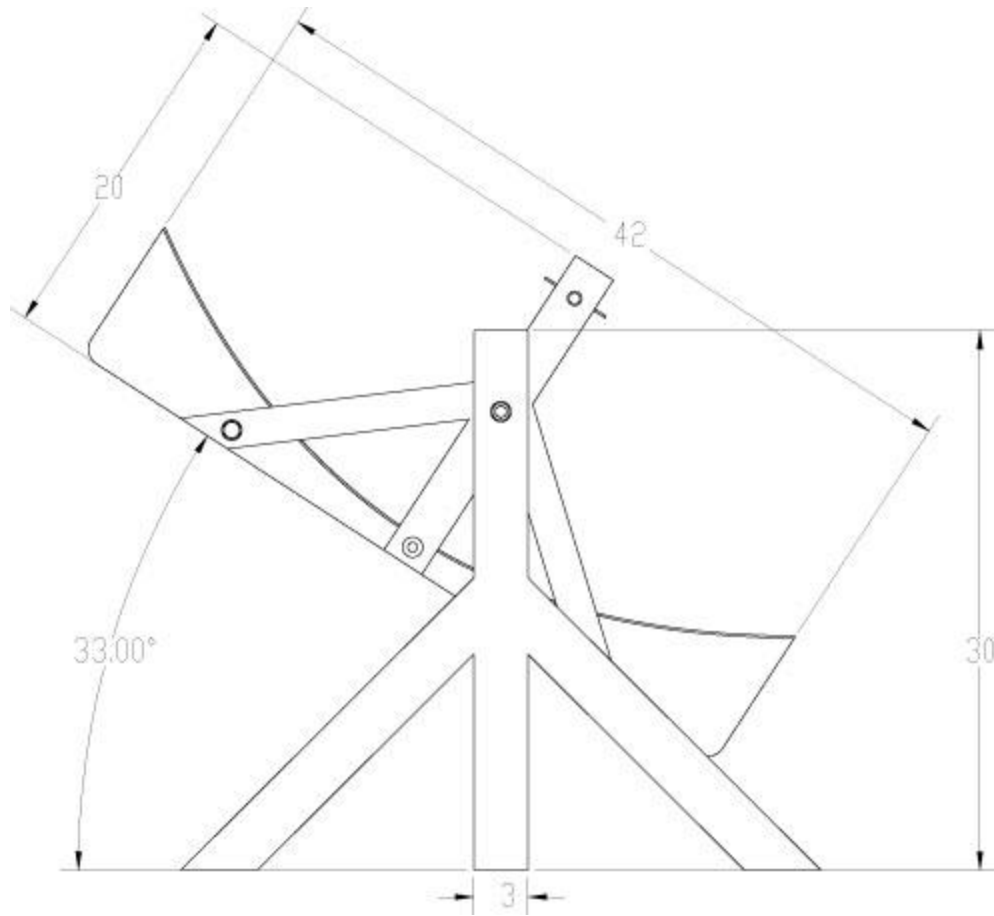


Figure C.3 Orthographic dimensions of the solar collector