

The DC Transformer

By Inventor Newton E. Ball – March 2017

Background – The DC Transformer is a wonderful invention that should have happened about thirty years ago, when electronic switching by mosfet became efficient, compact and cheap. A DC transformer is generated by adding a number of overdriven mosfets to an AC Transformer. DC transformers will be very useful in the emerging battery driven DC world. They will allow cell balancing for solar cells and most any kind of electrochemical cells. In solar photoelectric arrays, the diodes will disappear, and partial shading will no longer cause disproportionate energy loss. DC motors, of any voltage, will be driven from DC cells of any voltage, with only a DC Transformer interface. A single smart charger for lead acid batteries, can charge 6V, 12V, and/or 24V batteries, at the same time, whether or not the batteries are connected to their vehicle, or other loads, and regardless of their state of charge, at connection.

Present DC-DC converters aren't DC transformers– Both the converters and transformers can deliver energy from a source at one voltage and current, to a load at a different voltage and current. But a transformer, AC or DC, does it in a way that no Pulse Width Modulation [PWM] circuit can.

A transformer creates a reversible, turns ratio controlled, link, between two or more ports. The linkage is stiff, and nearly instantaneous.

+

The link refers voltages in direct proportion to turns ratio, current inversely to turns ratio, and, therefore impedance, directly as turns ratio squared.

A

This has been established transformer theory, for approaching 100 years. It was taught to me, in my junior year, at CAL Berkeley. It may have been dropped, for you, younger folk, in favor of coding.

Diagram of a 1:1 DC Transformer -

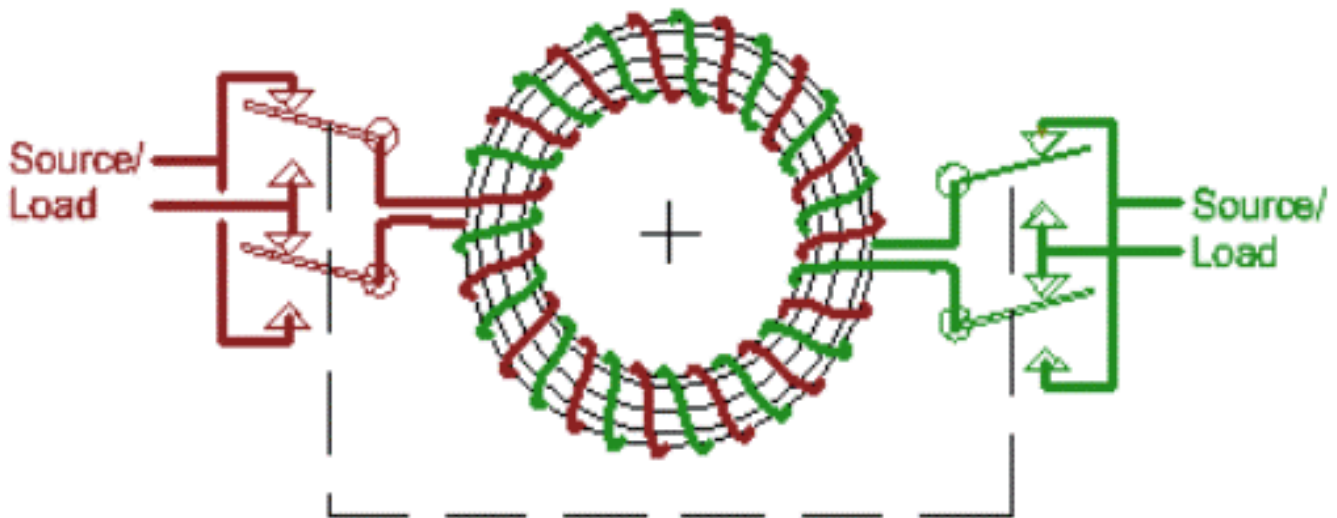

B

Single Sentence Invention Abstract -

If an array of switches reverses the connection of each winding of an AC transformer simultaneously, and periodically, then the low frequency response of the array-transformer assembly, is thereby extended to include DC, and the assembly is, in fact, a DC Transformer.

C

Acts like a transformer, because it IS a transformer, switch-connected -

This means that the fast reflection characteristics of a transformer survive the extension of the low frequency response.

A DC Transformer with high turns ratio -

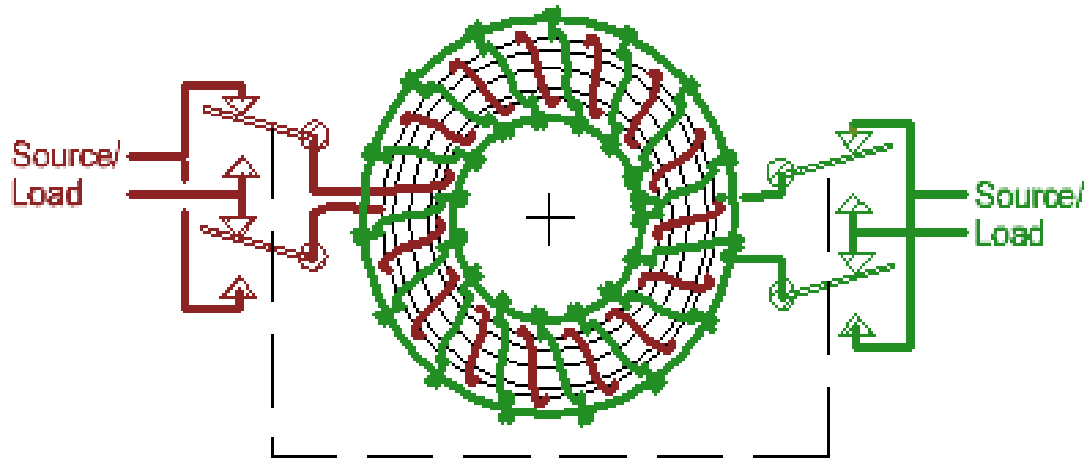

D

This diagram is not quite as easy to read, as the last. Red is 15 turns, connected in series, routed to the left port. Green is 15 single turns, connected in parallel, routed to the right port.

A DC Transformer for Point of Load [POL] 1V from 48V bus -

Now please imagine 96 turns in series, routed to the 48V port, and a number of two turn windings, in parallel, routed to the 1V port. Here is a physical 2 microfarads of capacitance, [physical part displayed] a reasonable local bypass on the 48V Bus, close to a microprocessor card. What does it look like, to the card, as viewed through the transformer?? Here is 4600 microfarad capacitor, [physical part displayed] 2 microfarads **Transformed**, by a 48 to 1 turns ratio. There is no forward converter, or other clocked PWM topology that can come anywhere near this performance! This transformation is nearly instantaneous, and completely independent of the reversal rate. Reversal rate is expected to be between 50KHz, and 150KHz. Delay will be a few nanoseconds.

Reflection Delay -

Reflection delay is directly affected by leakage inductance. Ordinary transformer construction, results in a ratio of magnetizing inductance to leakage inductance, of a hundred or so. By using core shapes with circular cross section, wound over their entire path length, and windings with the same lead, and same lay, for all layers of all windings, my models have a ratio above 4,000 and I expect improvement going forward.

Pause for Discussion –

This is the essence. There are interesting bells and whistles. There are regulators with continuous port-to-port linkage. There are AC-DC bisexual transformers. But they all depend on acceptance, maybe even understanding, of the forgoing.

Transformer Switch Drive -

This is the schematic of the first working model.

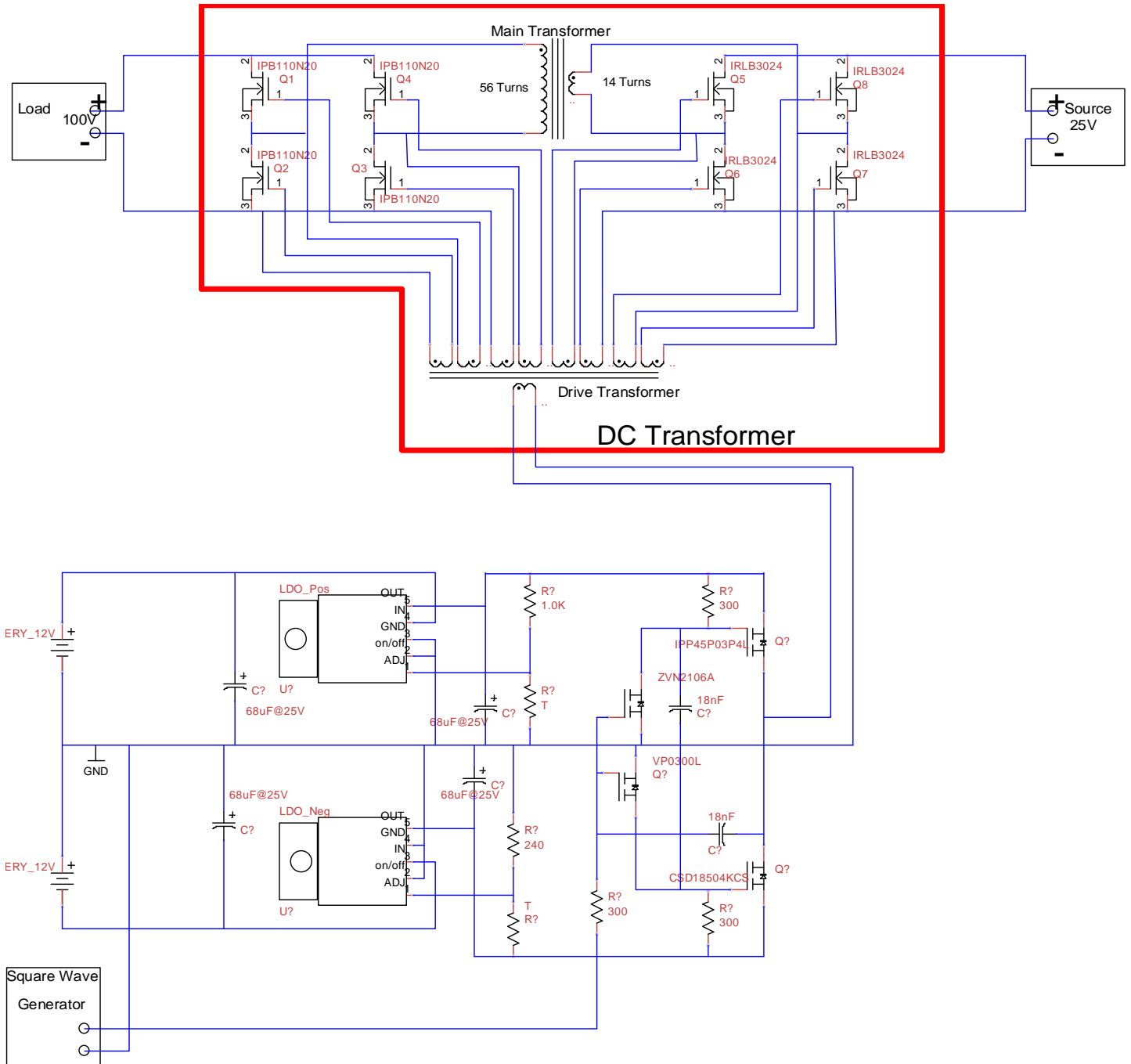

E

The switch drives need to be isolated, in many cases, so the easy thing to do from the design point of view, is to drive them with a transformer. The transformer could be much simpler, if complementary switches worked well, but P-Channel mosfets are an order of magnitude higher R_{ds-on} , than N-Channel.

Some Switch Forms -

Switched Terminals

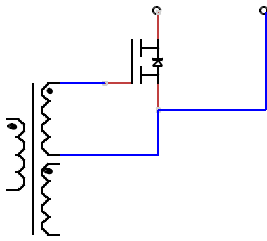

Simple N-Channel Form-A
Unipolar

Switched Terminals

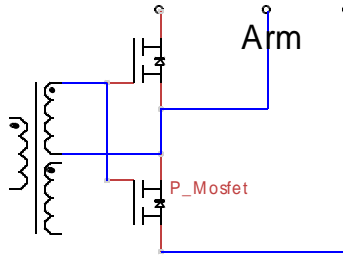

Complimentary Form-C
Unipolar

Switched Terminals

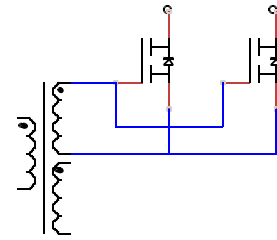

Dual N-Channel Form-A
Biipolar

F

I think that you can see that the drive transformer in the overall schematic, would need only half as many secondaries, using the complimentary switch form.

AC/DC Transformer -

If bipolar switches are used throughout, then the DC Transformer can run between ports, that have voltages that contain AC, and/or DC, in any proportion. Repair replacement transformers, throughout an AC power grid system, will be smaller, lighter, and safer, when they are made this way. I do not expect to live to see this, but some of you might. I won't be making any of these, for several years, so students can be first to make, test, and publish.

Cores for the Next Model -

The first model was built on toroidal cores, and uses no printed board. It has been shown to pass substantial power in either direction, but I am delaying performance measurement for a printed circuit model.

Planned Next DC Transformer

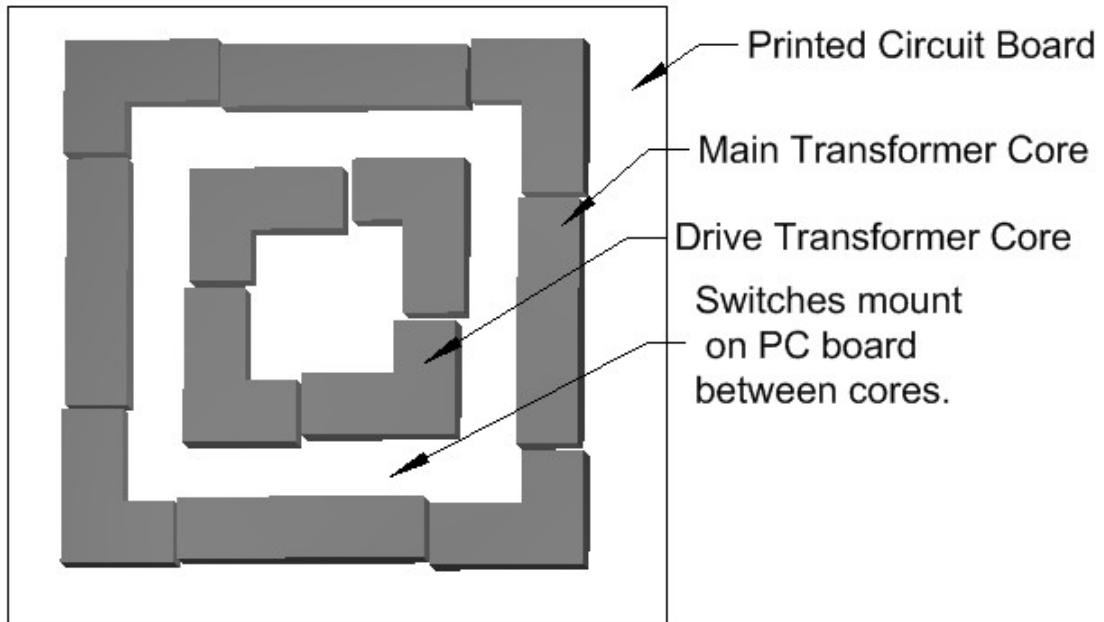

All core pieces have 1/4" X 1/4" cross section.

Cores are from power ferrite material like Ferroxcube 3F3 or Mag-Inc P.

Gaps are illustrative, to show pieces. Finished article will have no gaps.

Regulation with Linkage Intact -

I don't know whether any of you have ever seen a motor driven Variac. It is the inclusion of an AC transformer within a control loop. They are slow, and they don't provide isolation, but they provide continuous regulation, without compromising the transformer's basic referral functioning. The post-modern analog of the motor driven Variac, is the Hysteretic Tap-switching DC Transformer. This involves one form-C switch per turn, on one end of the highest turn winding of the DC transformer, and this could be a lot of switches, but switches are very tiny, and very cheap, and the end result can preserve isolation, and preserve reflection, while replacing any forward converter, any Cuk converter, any Pulse Width Modulation [PWM] topology whatever, with regulation, along with fast referral. When this is widely adopted, probably not within my lifetime, and probably, not initially within the United States, 96% efficiency will be considered a floor, and 99+% will be commonplace.

Personal Goals -

Universities tend to call consultants "contractors". They don't want to admit to any knowledge deficit. I would like to be a contractor to a school, probably a foreign technical institute, rather than a university, that had a magnetic laboratory capability, and would pursue the DC Transformer, and better ways to construct, and apply it.