



# Take Climate Change Preparation Into Your Own Hands

Do-it-yourself guides to better food production

# Contents

---

<b>1</b>	Introduction	pg.3	<b>6</b>	How to make a wood-burning institutional stove	pg.33
<b>2</b>	How to Build a Vertical Aquaponic System	pg.5	<b>7</b>	How to make a PVC and bamboo seed planter	pg.39
<b>3</b>	How to Build a Sack Garden	pg.16			
<b>4</b>	How to Make a Worm Composting Bin	pg.23			
<b>5</b>	How make a 3D-printed corn sheller	pg.29			

# Introduction

---

## Open Source Appropriate Technologies Improve Self-Reliance

Joshua M. Pearce

Farmers need to improve their farms and add value to their crops to bolster their resilience to changing climates. Both droughts and floods will be easier to manage with more food in storage and savings in banks.

Fortunately, a growing movement to share open source appropriate technologies (OSAT) enables farmers to make many of the tools they need themselves from freely available online plans. OSAT refers to technologies that are designed in the same fashion as free and open-source software. However, these technologies must be "appropriate technology" (AT), meaning technology that is designed with special consideration to the environmental, ethical, cultural, social, political, and economical aspects of the community for which it is intended. The OSAT movement has been growing for some time and is largely focused on farmers. Often, and particularly in the developing world, these technologies are small scale, elegant, and simple, yet

provide for people's needs without destroying the capacity of the Earth to support life.

There are many places on the Internet that provide access to OSAT. One of the most prominent that works directly with communities all over the developing world is a wiki maintained by the Appropedia Foundation. Appropedia is a wiki-based website, like Wikipedia, where a large number of participants create and modify the content directly from their web browsers. They focus primarily on low-tech solutions, but also have advanced energy systems among other tools available. Another prominent group started at a farm in the U.S., known as Open Source Ecology (OSE), which is building the Global Village Construction Set. This is a modular, DIY, low-cost platform - that allows for the easy fabrication of the 50 different industrial machines needed to build a small, sustainable civilization with modern comforts. They have already developed an

# Introduction

---

open-source tractor. In addition, Engineering for Change has been developing a formidable Solutions Library, which features some technologies that include free construction guides. Lastly, it is remarkable that OSAT for farming works just as well in your backyard in a city in a developed country as it does in remote rural villages in Africa. This enables other platforms like the Engineering for Change guides at Instructables to be used by everyone the world over. All the information developed by Appropedians, OSE, Engineering for Change and the wider OSAT community is free for others to use to solve their own sustainability problems.

Wikipedia grew exponentially, and is now one of the top ten sites on the Internet with content created by thousands of volunteers beating multi-billion dollar international companies. In the same way, OSAT is becoming a true rival to the paradigms of the development of technology that have dominated civilization since the industrial revolution. A new revolution, built on a dispersed network of innovators, inventors, and researchers working together to create a just, sustainable world is being created. Perhaps most exciting is the potential for the direct digital manufacture of farm equipment on site using modern low-cost open-source 3D printers. Many applications have already been demonstrated

for small farms. In this chapter we demonstrate this ability with a low-cost customizable corn sheller.

To provide a broader overview of OSAT for farming, we present a selection of step-by-step pictorial construction guides that show how to make a range of devices that can increase family food supplies, streamline farm work and process and cook food. Read on for do-it-yourself construction guides to tool for the home and farm.

Remember all of these tools are open source!so if you make one and improve upon it please remember to reshare your improvement with the global community!



Joshua M. Pearce

Director of Michigan Tech's Open Sustainability Technology Lab in the Department of Materials Science & Engineering and Department of Electrical and Computer Engineering at Michigan Technological University

A vertical aquaponic system is shown, constructed from white PVC pipes and red plastic cups. A central vertical pipe has several circular holes cut into it. This pipe is connected to a horizontal pipe that runs across the top. From this horizontal pipe, several smaller pipes lead down into red plastic cups. Water is seen flowing from the central pipe into the cups. The system is supported by wooden planks and is set against a dark, textured background.

# How to Build a Vertical Aquaponic System

# How to Build a Vertical Aquaponic System

You can turn a small yard, a corner in a community garden or an unused space in your home into a thriving vertical farm for vegetables and fish. A household-sized vertical aquaponic system can fit into a 3ft by 5ft (1m x 2m) area and feed a family year-round. [Sean Brady](#), the aquaponics projects coordinator at the [Center for Sustainable Aquaponics](#) and [Nourish the Planet](#) in Loveland, Colo., showed us how to build a system from scrap he found around the greenhouse.



## More Food, Less Water

A vertical aquaponic system grows vegetables without soil in columns above a fish tank. It is a water-efficient and space-saving way to garden and raise fish. By growing vertically, you can produce about twice the amount of plants as you can with a hydroponic system of the same area. One five-foot tower can produce more than 200 heads of lettuce per year. And it uses a small fraction of the water needed to grow crops in soil.

## Mutual Benefits

The aquaponic system puts fish waste to work as fertilizer for crops. A small pump draws nutrient-rich water from the fish tank to the tops of the vertical columns. The water trickles down through the roots of the plants, gathering oxygen from the air as it falls back into the tank. The system is mostly enclosed, with little to no waste and no need for fertilizer or pesticides. And, if you do it well, you won't have to clean the fish tank much.

# How to Build a Vertical Aquaponic System

---

You would have to replace lost water as needed, power the pump and feed the fish. It might not be too hard to power one of these pumps with a small solar panel or some other renewable energy. If anyone has an idea, please share.

This is how to build Sean Brady's low-cost vertical aquaponic system. All the photos are his, and if you have questions for him, you can [contact Sean Brady here](#) or email him at [bradyaquaponics@gmail.com](mailto:bradyaquaponics@gmail.com).

## Materials

You can use the following materials or swap out anything for whatever you have on hand. Brady built this system from scrap he had around the greenhouse. We're including pictures of other, fancier systems that he built out of similar materials to show the diversity that this kind of build affords. Measurements are in feet and inches. Sorry, rest of the world.

- Pipes
  1. 15-20 ft. of 4-in. diameter PVC or ADS
  2. Four 4-inch elbows
  3. Four 4-inch T connectors
- Two 50-gallon drums
- 15-20 ft. of pex tubing, or aquarium tubing
- 15-20 ft. of pex tubing, or aquarium tubing
- Strips of cloth, such as burlap sack, cable ties or another fastener
- Scrap wood
- Two rolls of electrical tape
- Pumps

One water pump – the size depends on how much flow it would need. An aquarium pump is enough to keep the flow going. One air pump (optional). The system can aerate itself but it can produce more if it has an air pump.

# How to Build a Vertical Aquaponic System

## Tools:

- Power drill or hand drill
- 1-in hole saw
- 3-in hole saw

## Build Time:

- About two hours.

## Recommended Plants and Fish:

Leafy vegetables, tomatoes and herbs do well in these systems. So do flowers. You can experiment to find which do well and fit your needs.

Tilapia and trout do well, they grow quickly and they're delicious.

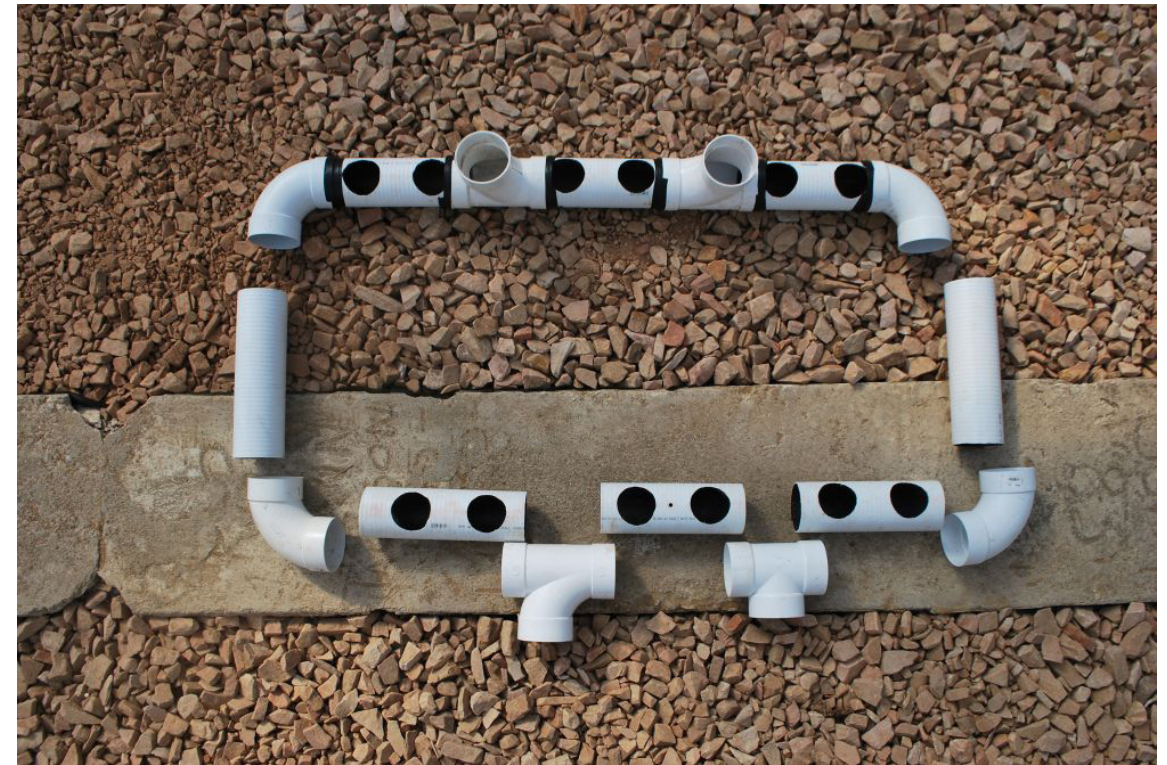

- Cut the pipe into six 1ft. sections for the sides and two 14in. sections for the ends.
- Drill two 3in-diameter holes in each of the 1ft side pieces.
- Drill a 1in-diameter hole into the side of one of the end pieces.
- Tip: You can use any kind of durable plastic or pipe, not just what's pictured.



# How to Build a Vertical Aquaponic System



- Assemble the pieces with electrical tape.



- Cut the vertical pipes to the length that suits you.
- Drill 1in-diameter holes in the vertical pipes, evenly spaced.
- Insert the vertical pipes as shown.
- The photo on the right shows the mostly finished structure to give you an idea of how it looks.

# How to Build a Vertical Aquaponic System



- Perforate the bottoms of the plastic cups and place them in the holes you drilled in the side pipes.
- Cut a piece of 1in-diameter pipe to insert into the 1in hole in the end pipe to make a drain.
- The drain should pour into one of the 50-gallon drums.



- You can use two 50-gallon drums like these or any other kind of container that holds water for fish. You could even scale this down and put it on top of an indoor aquarium.

# How to Build a Vertical Aquaponic System



- Cut the tops off below the rims.



- This is the assembled garden structure on top of the drums, seen from two slightly different angles.

# How to Build a Vertical Aquaponic System



- Adjust the structure's balance and support its joints with wooden boards. You could tilt the structure slightly toward the drainpipe to improve the water flow.
- Most systems will have vertical columns of equal height, but these are cut at different heights to show the range of options available.



- Seed the plants in these. Put them in the cups and the holes in the vertical columns.

# How to Build a Vertical Aquaponic System

The final steps are not pictured, but easily explained. Cut strips of burlap or some other material, fasten them to the tops of the vertical pipes and drape them down the inside of the pipes. Stuffing the pipes with cloth like this will give the plant roots something to latch on.

Next, cut and assemble the tubing so that you can pump water from one barrel up to each of the four vertical pipes. You could also pump water from the barrel that receives drainage to the barrel that feeds the system.

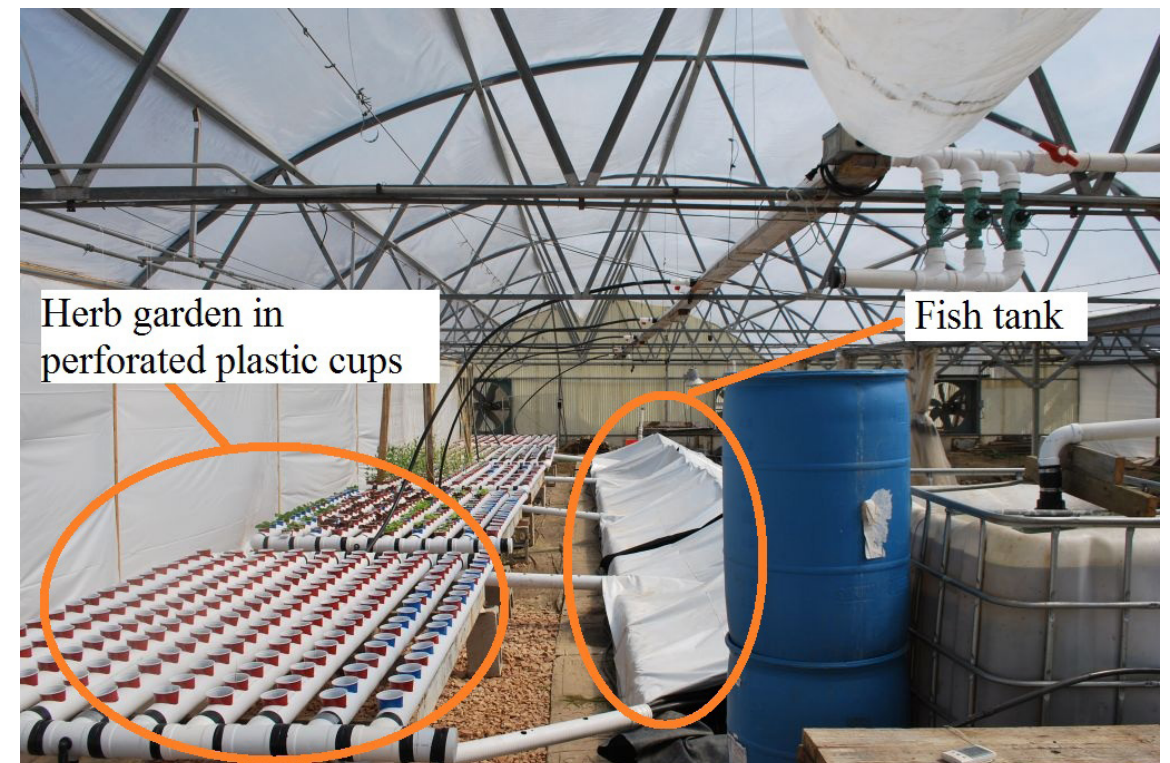

These systems can scale up to commercial size, too. Brady and his colleagues at the Center for Sustainable Aquaponics set up this greenhouse for leafy vegetables, herbs and fish.

# How to Build a Vertical Aquaponic System



Another view of the commercial greenhouse.



This arrangement portrays some of the creativity and even the beauty possible with an aquaponic system. Among its features, there is a rocky waterfall into the fish tank and a drip-irrigation system watering soil-free plants in a rock bed.

# How to Build a Vertical Aquaponic System



These are different views of the above system.



Our guide Sean Brady shows what these systems can produce. He's holding a trout here.



# How to Build a Sack Garden



# How to Build a Sack Garden

---

A garden in a tall sack is a simple home project and a good solution for city homes that don't have much outdoor space. We made one for the first time in a couple of hours, leaned it against the side of a house and planted it with hot peppers, basil and sweet potatoes.

Sack gardens can work in any city, but they can be especially important in developing countries and urban slums. Growing superfoods like kale, spinach and root crops not only cuts grocery bills, but infuses otherwise poor diets with vitamins and other nutrients. Woven plastic feed bags, food aid sacks burlap and other large bags have been converted into upright gardens in cities in Kenya and Uganda, schools in India, communities in Mozambique, South Africa and the Philippines. A good example comes from the UN Food and Agriculture Organization, which published notes from an interesting discussion of a garden program in Kibera, Kenya, by the French non-profit Solidarites International.

We took tips for our how-to guide from Appropedia's and Gardens for Health's bag garden pages and Send a Cow's video tutorial for making a bag garden in Uganda. This is how we did it.

## Materials

- 1 burlap coffee sack, feed sacks and food aid sacks work, too, as would any large bag.
- 3 cubic feet of soil. We used organic compost, but a soil-manure mixture would work, as would compost from an ecological toilet, a household waste compost bin or any nutrient-rich soil.
- Gravel. A large yogurt container with the bottom cut off. Coffee cans or other similar-sized containers also work.
- Starter plants. We planted serrano and habanero chiles, sweet potato, sweet pepper and two kinds of basil.

## Build Time

We spent about one hour gathering the materials and 1.5 hours putting it together the first time. It could go much faster once you know what you're doing.

# How to Build a Sack Garden



We started with compost, gravel, a burlap coffee sack and a large yogurt container with the bottom cut out.



Our starter plants are two kinds of chile pepper, two kinds of basil, sweet potato and sweet pepper.

# How to Build a Sack Garden



Put a shallow layer of soil in the bottom of the sack, place the yogurt container (or coffee can or a similar container) in the center and fill it with gravel.



Shovel the soil around the rock-filled container and fill out the sack to the edges. When the soil reaches the top of the container, pull it up gently, leaving the rocks in a column in the center. Repeat until the bag is full with a center column of gravel. The column is for drainage and water distribution throughout the sack.

# How to Build a Sack Garden



Filling the sack.



Pro tip: Put root crops on top and leafy vegetables and herbs in the sides.

# How to Build a Sack Garden



Plant the top of the sack.

- Cut a small hole in the sack for planting along the sides.
- Pro tip: We cut the holes too big. Try making a small cut that looks like an upside down "T," then scoop out soil from below the cut to make a little shelf for the plant.



The finished sack garden. This can hold more plants, but we settled on six.

# How to Build a Sack Garden



A different angle.





# How to Make a Worm Composting Bin

# How to Make a Worm Composting Bin

Last year, trash clogged the gutters and alleys between of Los Platanitos, a community on the outskirts of Santo Domingo in the Dominican Republic. The government waste collection service was unreliable, so people dumped their trash where they could. The problem was so bad that backed up drainage channels flooded homes during heavy rains. Now, worms in composting bins are solving part of the problem. A team from the University of Texas in Austin built vermiculture composting bins to turn food waste into fertilizer. Dinner scraps, rinds, peels, crusts and nearly anything organic can feed the worms. Now they just need to dispose of the rest of the waste (we have a few ideas for [plastic bottles...](#) and [almost anything else](#)).

The community experimented with several bin construction ideas, including cinder blocks, plastic 55 gallon drums, and even an old refrigerator shell that had been stripped for parts. Their creativity inspired us to upcycle a refrigerator into a vermiculture bin. But we went with a mini fridge for use for a single household.

We began the project at Kokua Worms, a vermiculture supply depot in Honolulu, Hawaii, where we learned about worms and the principles of vermiculture. This is how to build a worm composting bin, and how to care for your worms.

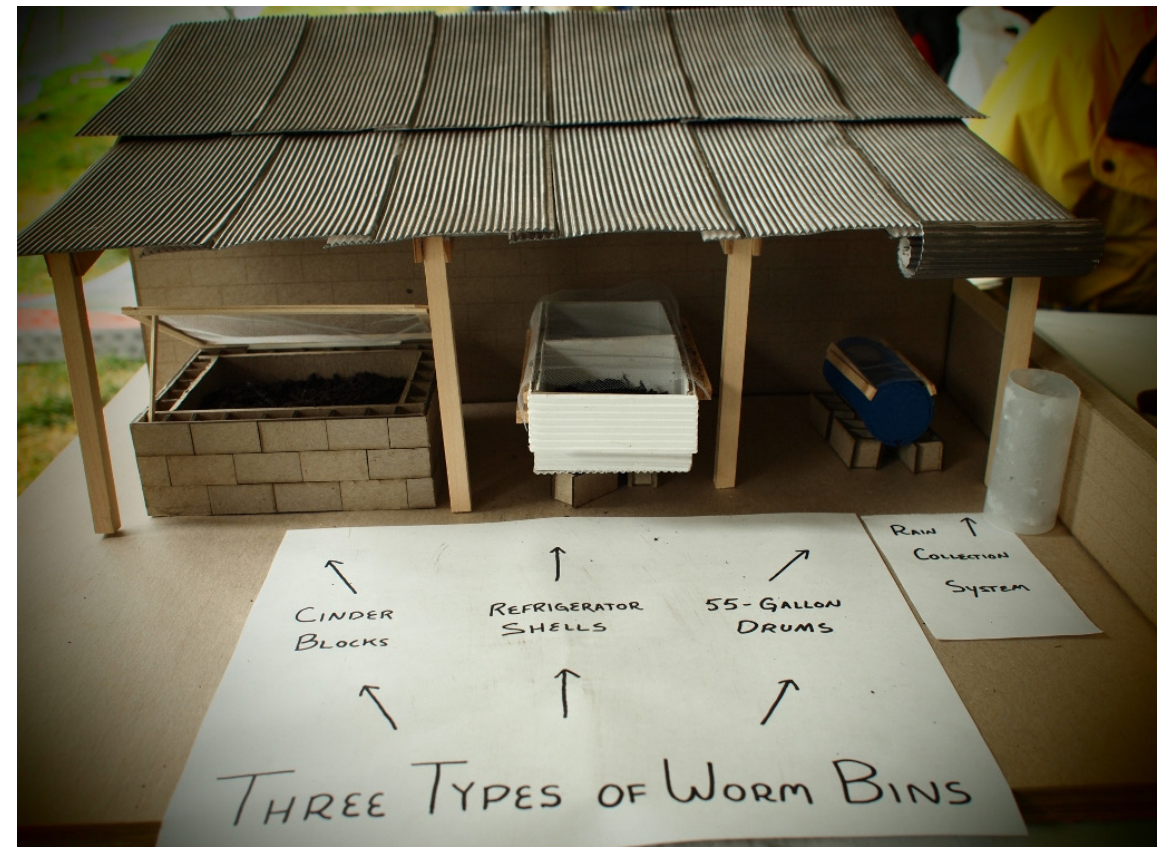

A team from the University of Texas, Austin built this crazy little replica of their work in Los Platanitos, in the Dominican Republic, to explain their vermiculture solution to trash in the streets. The team won a US EPA P3 grant to carry out some of their work. These are three bins built from different materials that they have tested. We like the idea of using a refrigerator shell. Photo by Rob Goodier



# How to Make a Worm Composting Bin



This mini fridge was destined for a landfill before we commandeered it for worm composting. First, we removed the door, the cooling tray and the motor. Photo by Rob Goodier



Worms in bins need three basic things: food, ventilation and drainage. We perforated the back of the fridge, which will be the bottom of the worm bin, to allow for drainage. Ventilation will come through the top. Photo by Rob Goodier

# How to Make a Worm Composting Bin



We placed our bin on broken cinder blocks to elevate it and improve drainage. The leachate that seeps out is full of nutrients for plants. It's okay if it drains into the soil, but we wanted to collect it to feed to other plants in the garden. To do that, we slipped a discarded trashcan lid under the bin. Photo by Rob Goodier



Layers, layers layers. That was what we learned at Kokua Worms. First, place a layer of shredded newspaper or other cellulose-rich material. We chose newspaper plus coconut husk. Then we sprinkled it with the "worm poop" soil that our worms came in. Then we released the worms. The next layer is food scraps. On top of all of it, we placed another layer of shredded newspaper and topped it with a damp towel.

Photo by Rob Goodier

# How to Make a Worm Composting Bin



Kokua Worms recommends using two varieties: Red Wigglers (*Eisenia fetida*) and Indian Blue Worms (*Perionyx excavatus*). They are hard to tell apart by sight, but both are wriggling around in this handful of worms. Photo by Rob Goodier

We started our worms on a diet of watermelon rinds, lime and mango peels, a few yard clippings and coffee grounds. We were warned to avoid meats and fatty foods because they can smell bad. And papaya seeds can make the worms sterile.



We plan to feed the worms every other day. They need food at least once per week, and the more feedings the better. They can eat their weight in food every day! And make sure to water them, too. The shredded newspaper should be damp. Photo by Rob Goodier

# How to Make a Worm Composting Bin



With enough food scraps and water, the worm population should have plenty of room to grow in this fridge shell. Six months from now we'll peel back the top layers and harvest the first batch of "worm poop" compost. Photo by Rob Goodier

We cut a piece of plywood to loosely cover the top of the bin and allow for air circulation while protecting it from playing kids and stray basketballs.



Kokua sells other styles of worm composters. Clockwise from the top left, this is a modular stacked tray system that can expand as the worm population grows. Worms pass between the bins through the drainage holes; The Piece of Pipe bin drains into a wide stand below the compost; The oval specks are worm cocoons that hold four to six baby worms; The Worm Hangout is a continuous flow system that allows you to harvest the compost from the bottom. Photos by Rob Goodier

A close-up photograph showing a person's hands using a white, 3D-printed corn sheller. The sheller is a cylindrical device with a central opening for the corn cob. The person is holding a red corn cob inside the sheller, and the device is being rotated to peel the kernels. The background is slightly blurred, showing a table with other corn cobs and a person wearing a blue hat. The text "How to Make a 3D-Printed Corn Sheller" is overlaid in white on the bottom left of the image.

# How to Make a 3D-Printed Corn Sheller

# How Make a 3D-printed Corn Sheller

## AGRICULTURE, ICT

Shelling corn by hand is hard, long and boring work, but in some parts of the rural developing world it is the only way to remove the kernels from the cobs.

If only everyone had a handy corn sheller. The problem is that commercial shellers are too expensive for most families and cheaper versions, if they're available in a region at all, are one-size-fits-all. Corn comes in different sizes depending on the variety grown, soil, weather and other conditions and also on the season. A single-sized sheller might not be suitable year round, so customized versions could be useful.

The do-it-yourself corn sheller is a good option, and E4C has reported on a series of [low-cost shellers](#) that upcycle materials like tin cans and PVC pipe. But these can also be a chore to make.

3D printers have become increasingly accessible, and using these tools, my team and I at the Michigan Tech Open Sustainability Technology Lab have developed a solution to [the corn sheller](#) problem. This is how to 3D print a customizable corn sheller. It is an example of [open-source appropriate technology \(or OSAT for short\)](#).

By using a [low-cost RepRap](#) (self-replicating rapid prototyper) 3D printer, or a [solar-powered version of the RepRap](#), anyone can easily print out the right corn sheller for their needs. This academic paper explains how [3-D printing could be a powerful tool](#) for pulling people out of poverty in the developing world. Here we will look at how it can improve the simple corn sheller.

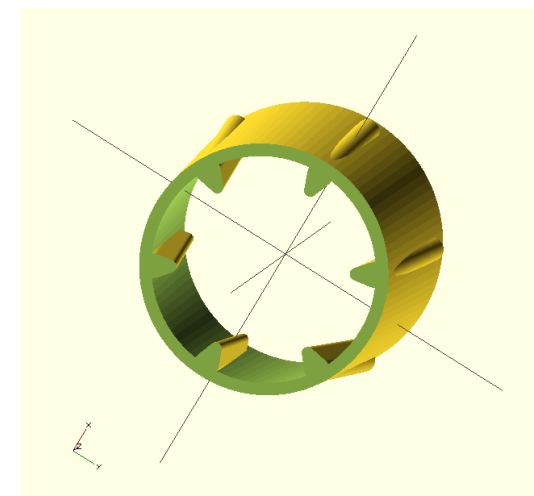

The corn sheller was designed in an easy-to-learn script-based CAD package called OpenSCAD. See the rendering of the standard sheller above. The cornsheller is completely parametric, meaning people themselves can change the size, shape, and number of fingers that strip away the corn.

# How Make a 3D-printed Corn Sheller

Here you can either use the [customizer app](#) or the [OpenSCAD](#) to get the right size of sheller for your crop, then print in plastic or metal.

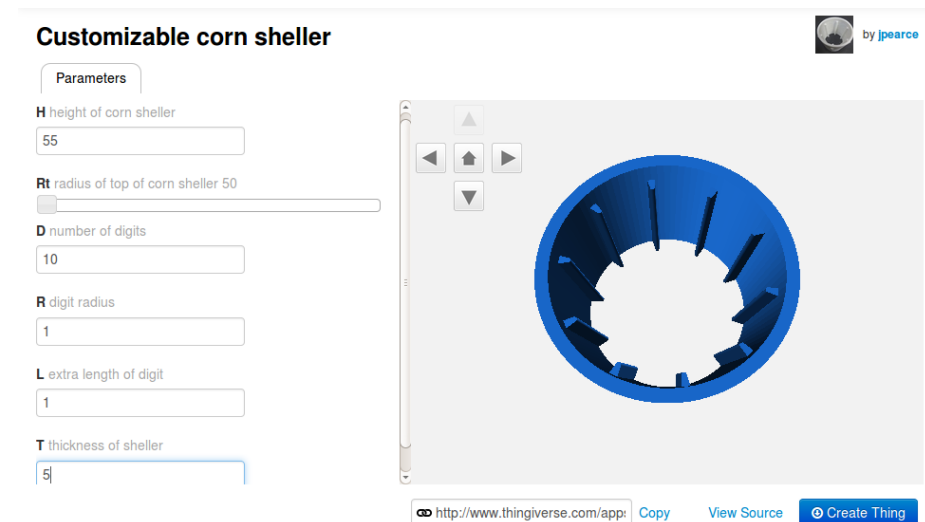
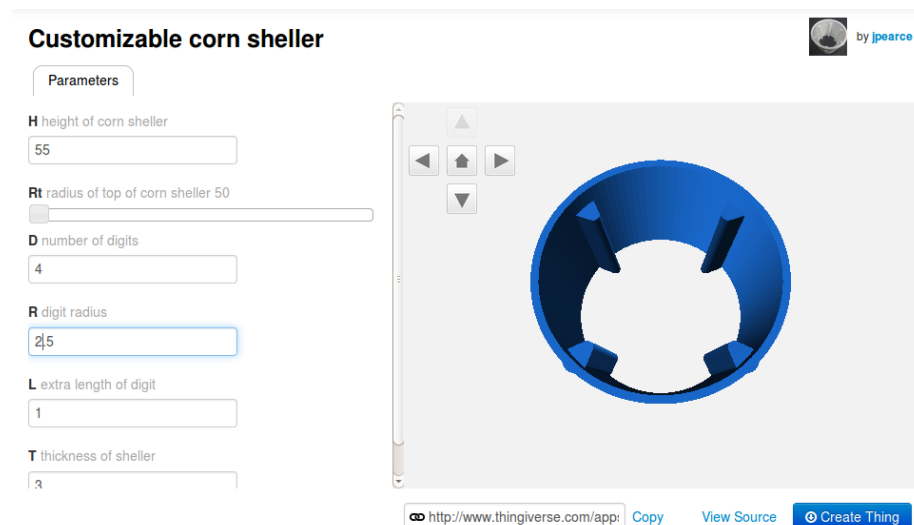
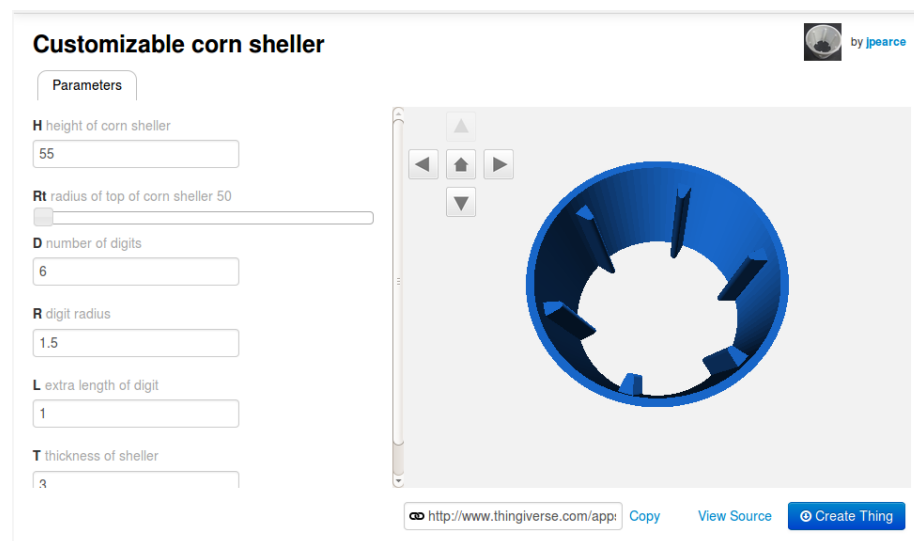

The customizer app enables people without any knowledge of CAD to design their own sheller. Note in the three images above that there is an automatic change in design between the three customized shellers.

# How Make a 3D-printed Corn Sheller



Watch Video through this link <https://youtu.be/DYGctL7tED4>

As the video shows, to shell corn by hand you have to crack the cob in half, pick out the first row and then strip off the rest of the kernels. But with a sheller it is much easier.

Testing with children in the U.S. showed that in general they could not shell the corn by hand because they could not get it started. However, the printed corn sheller makes it easy even for those under 5 years old to shell.

Being able to quickly and easily change the diameter of the printed corn sheller as shown above again makes it easy to get the best and fastest shelling for your specific corn. Note the blue sheller is about 80 percent of the diameter of the white one and is better at shelling the corn shown.

Joshua Pearce directs Michigan Tech's [Laboratory in Open Sustainability and Technology](#).



# INSTITUTIONAL STOVE CONSTRUCTION

BY: CHARLES NEWMAN  
CHARLESNEWMANDESIGNER@GMAIL.COM

AFTER BUILDING THE STOVE, LET IT DRY FOR ONE WEEK BEFORE USING.

ALSO, FIX THE ROOF TO PULL SMOKE OUT OF THE KITCHEN. THERE IS A LOT OF WIND IN UKAMBANI FROM THE SOUTH-EAST. THE ROOF CAN USE THE WIND TO PULL THE SMOKE OUT.

HERE ARE TWO IDEAS:



USALAMA PRIMARY SCHOOL KITCHEN

①



②



## How to Make a Wood-burning Institutional Stove

# How to Make a Wood-burning Institutional Stove

## AGRICULTURE, HEALTH

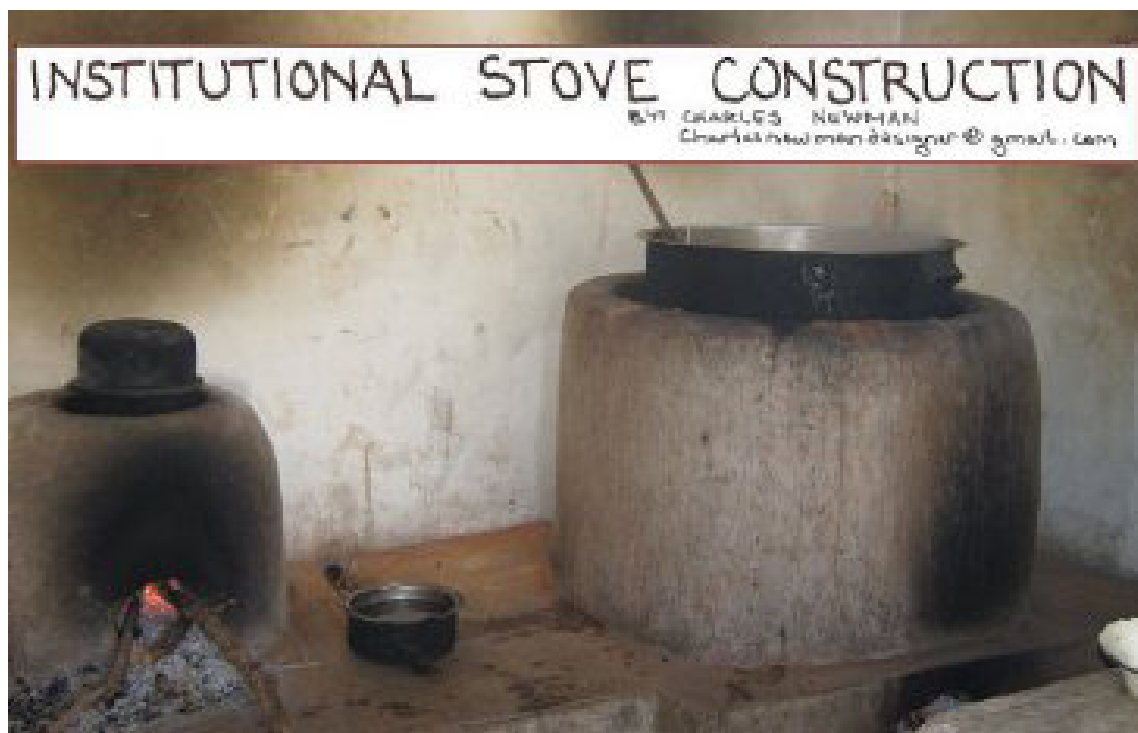

To get all of the wood-saving efficiency and smoke-minimizing power of the household cookstove on a much larger scale, we provide this guide to building a professional-sized stove for businesses, schools or clinics. The guide is hand-drawn by [Charles Newman](#), an architect and member of the Engineers Without Borders – USA New York Professional Chapter. Last year, Charles built and installed three versions of this stove in a grade-school kitchen in Usalama, Kenya. The stoves are part of a kitchen renovation that he performed on the slimmest of budgets (\$0.00). The stoves are still cooking in Usalama, and a copy of this same guide resides in the community's library.

Here we present Charles Newman's guide to building an efficient institutional stove.

The clean-burning stove is an old warhorse of design for developing countries, and for good reason. The right stove can cut the amount of wood needed and smoke produced in a kitchen by half. In poorly ventilated kitchens, the cook's exposure to smoky open cookfires could be about as bad as smoking a pack of cigarettes or more per day. By saving wood, efficient stoves take pressure off of forests, and the smoke reductions may actually [slow the rate of climate change](#).

# How to Make a Wood-burning Institutional Stove

Here we present Charles Newman's guide to building an efficient institutional stove.

## INSTITUTIONAL STOVE CONSTRUCTION

BY: CHARLES NEWMAN  
CHARLESNEWMANDESIGNER@GMAIL.COM

AFTER BUILDING THE STOVE, LET IT DRY FOR ONE WEEK BEFORE USING.  
ALSO, FIX THE ROOF TO PULL SMOKE OUT OF THE KITCHEN. THERE IS A LOT OF WIND IN UKAMBANI FROM THE SOUTH-EAST. THE ROOF CAN USE THE WIND TO PULL THE SMOKE OUT.  
HERE ARE TWO IDEAS:



USALAMA PRIMARY SCHOOL KITCHEN

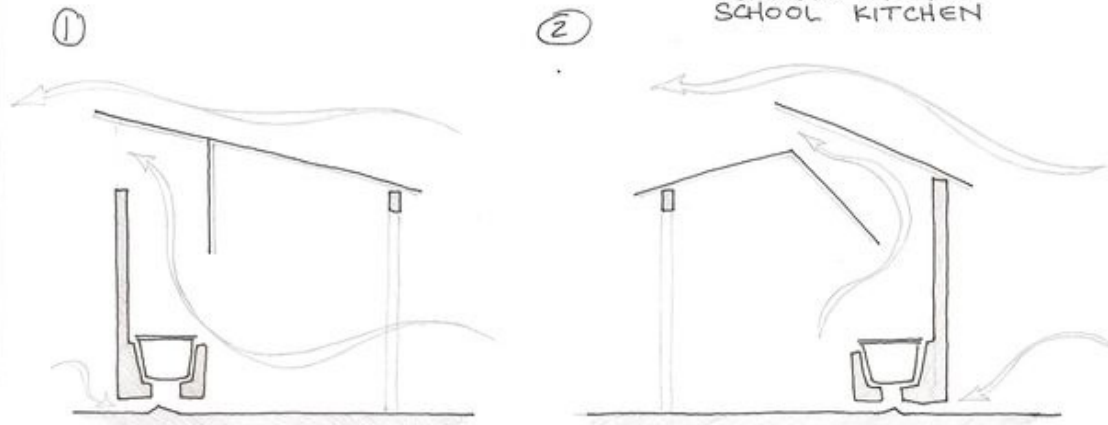

## INSTITUTIONAL STOVE CONSTRUCTION

BY: CHARLES NEWMAN  
CHARLESNEWMANDESIGNER@GMAIL.COM

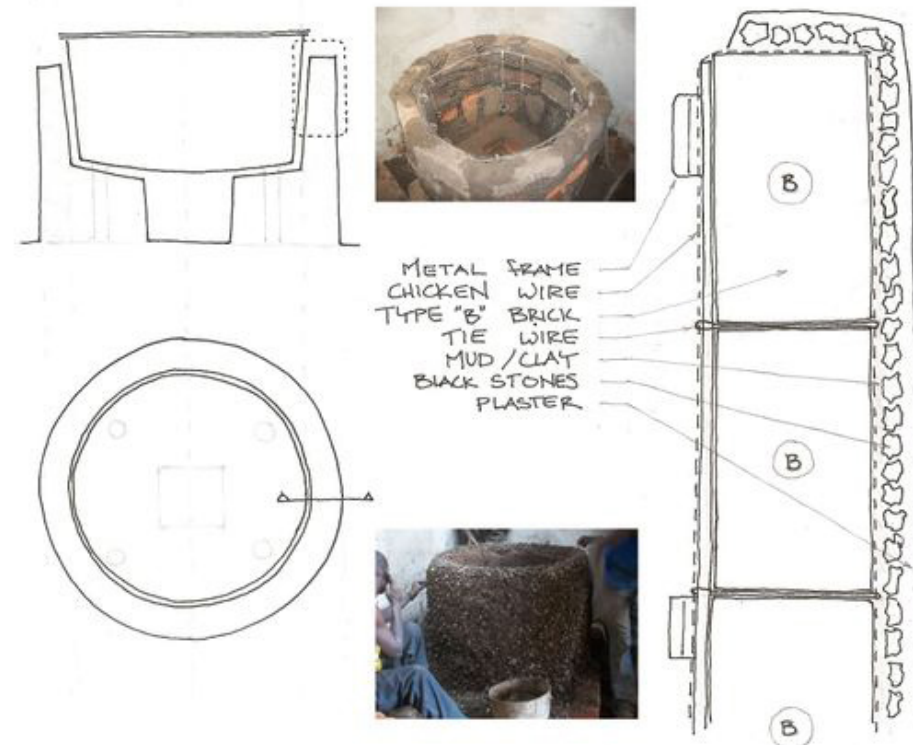

# How to Make a Wood-burning Institutional Stove

## INSTITUTIONAL STOVE CONSTRUCTION

BY: CHARLES NEWMAN  
CHARLESNEWMANDESIGNER@GMAIL.COM

IT IS VERY IMPORTANT TO LET WIND BLOW ON THE FIRE.

ALSO, WHEN COOKING, PLACE BRICKS OR STONE ("E") TO CLOSE THE WOOD ENTRANCE.



VIEW THROUGH FIRE SPACE

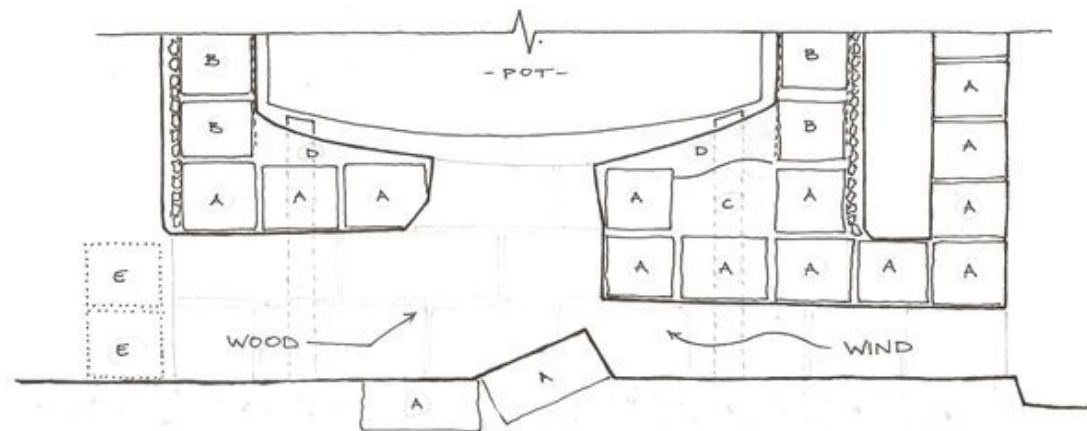

## INSTITUTIONAL STOVE CONSTRUCTION

BY: CHARLES NEWMAN  
Charlesnewmandesigner@gmail.com

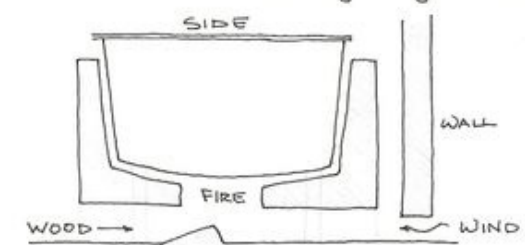
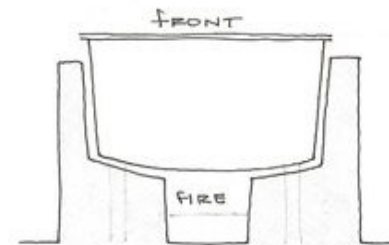

- \* BUILD AROUND METAL FRAME \*
- A STRONG BRICK
- B INSULATION BRICK
- C SAW DUST/MUD INFILL (1 to 1)
- D STRONG CLAY
- \* USE ONLY THIN MUD MORTAR JOINTS \*

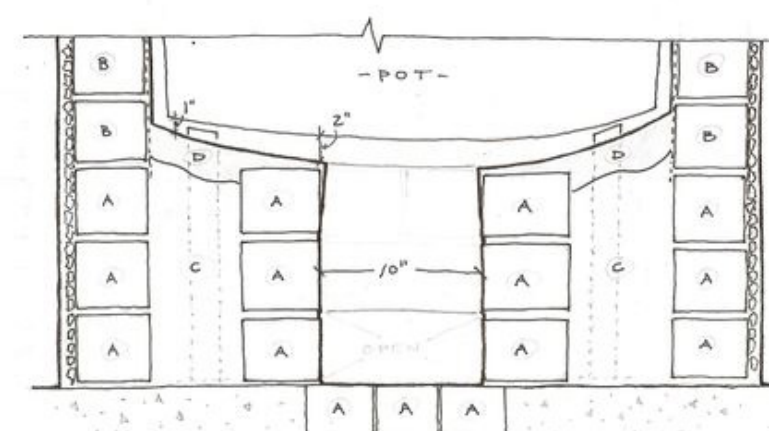

# How to Make a Wood-burning Institutional Stove

## INSTITUTIONAL STOVE CONSTRUCTION

BY: CHARLES NEWMAN  
CHARLESNEWMANDESIGNER@GMAIL.COM

### BRICKS



- THIS STOVE NEEDS ABOUT 100 GOOD BRICKS
- MAKE MORE THAN YOU NEED
- 2 KINDS OF BRICKS: 1/2 TYPE "A", 1/2 TYPE "B"

### (A) STRONG BRICK

- "REGULAR" BRICK
- CLAY OR SOIL + WATER



### (B) INSULATION BRICK

- CLAY + OTHER
- OTHER CAN BE:  
SAW DUST  
WOOD CHIPS  
DRY GRASS  
HAIR
- USE LOTS OF OTHER
- TRY DIFFERENT MIXTURES



(PHOTO BEFORE FIRING)

## INSTITUTIONAL STOVE CONSTRUCTION

BY: CHARLES NEWMAN  
Charlesnewmandesigner@gmail.com

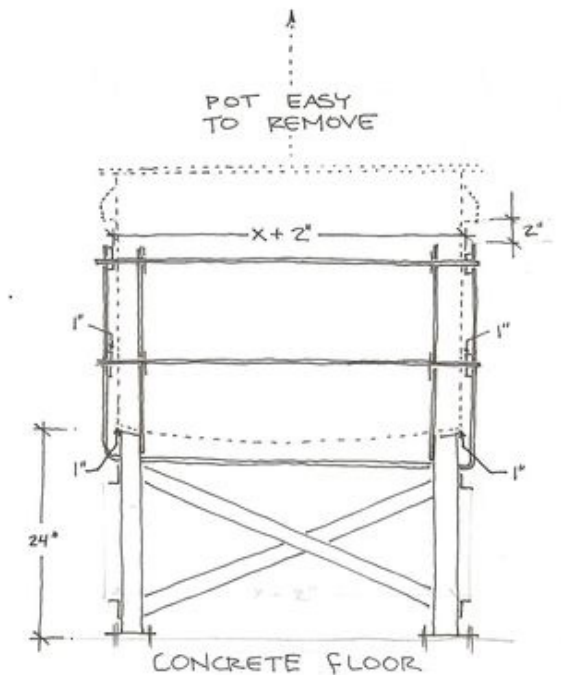
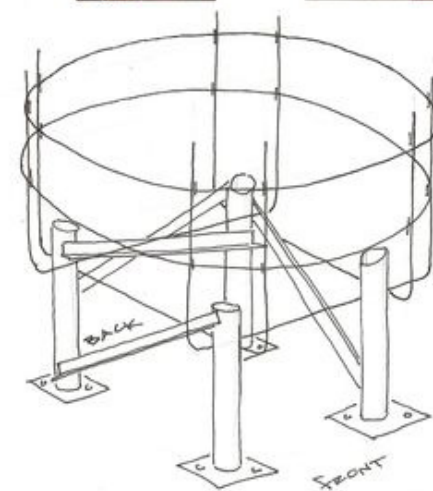

# How to Make a Wood-burning Institutional Stove

## INSTITUTIONAL STOVE CONSTRUCTION

BUILT BY THE PEOPLE OF USALAMA, KENYA  
DESIGNED WITH CHARLES NEWMAN (AUTHOR)  
(charlesnewmandesigner@gmail.com)



A person wearing a pink jacket and black pants is using a long, vertical pole to plant seeds in a field of tilled soil. The person is leaning forward, holding the pole with both hands, and appears to be in the process of planting. The background shows a field of brown soil with some green grass patches.

# How to Make a PVC and Bamboo Seed Planter

# How to Make a PVC and Bamboo Seed Planter

Gardeners and farmers can save their backs and plant seeds without stooping over when they use this handmade seed planter. [Thai rice farmers](#) had a hand in the design, but it could be used with other seeds.

The seeder is built from low-cost materials - mostly PVC pipe and bamboo. And, if you have them, you can use power tools to make it, but hand tools, including a machete, will work fine, too.

A team from Drexel University in Philadelphia, Pennsylvania is developing the seeder with rice farmers in Bo Klua, a community in rural Thailand. They've partnered with a local Thai organization called the Sustainable Development Research Foundation and produced a construction guide in English and Thai.

Both versions are available for free download.  
[English manual](#)

Alex Moseson, a sustainable development engineer and an assistant teaching professor at Drexel who heads the project, has asked Instructables and [E4C users](#) for ideas and tips on how to improve it. He would also like to see people modify the design to suit their own farming and gardening needs.

As such, Moseson gave the seeder a Creative Commons Attribution-Non-Commercial license.

For more on the seeder and the project in Bo Klua, please see the Drexel team's site.

## Step 1: Materials

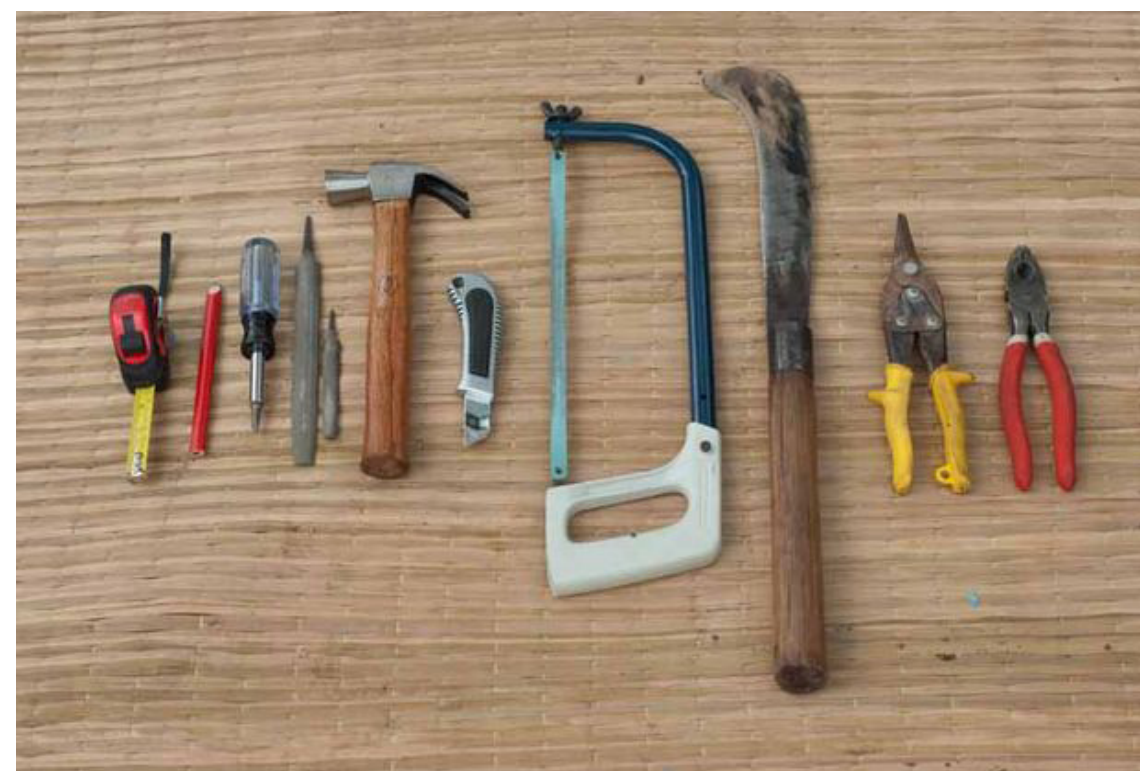



# How to Make a PVC and Bamboo Seed Planter

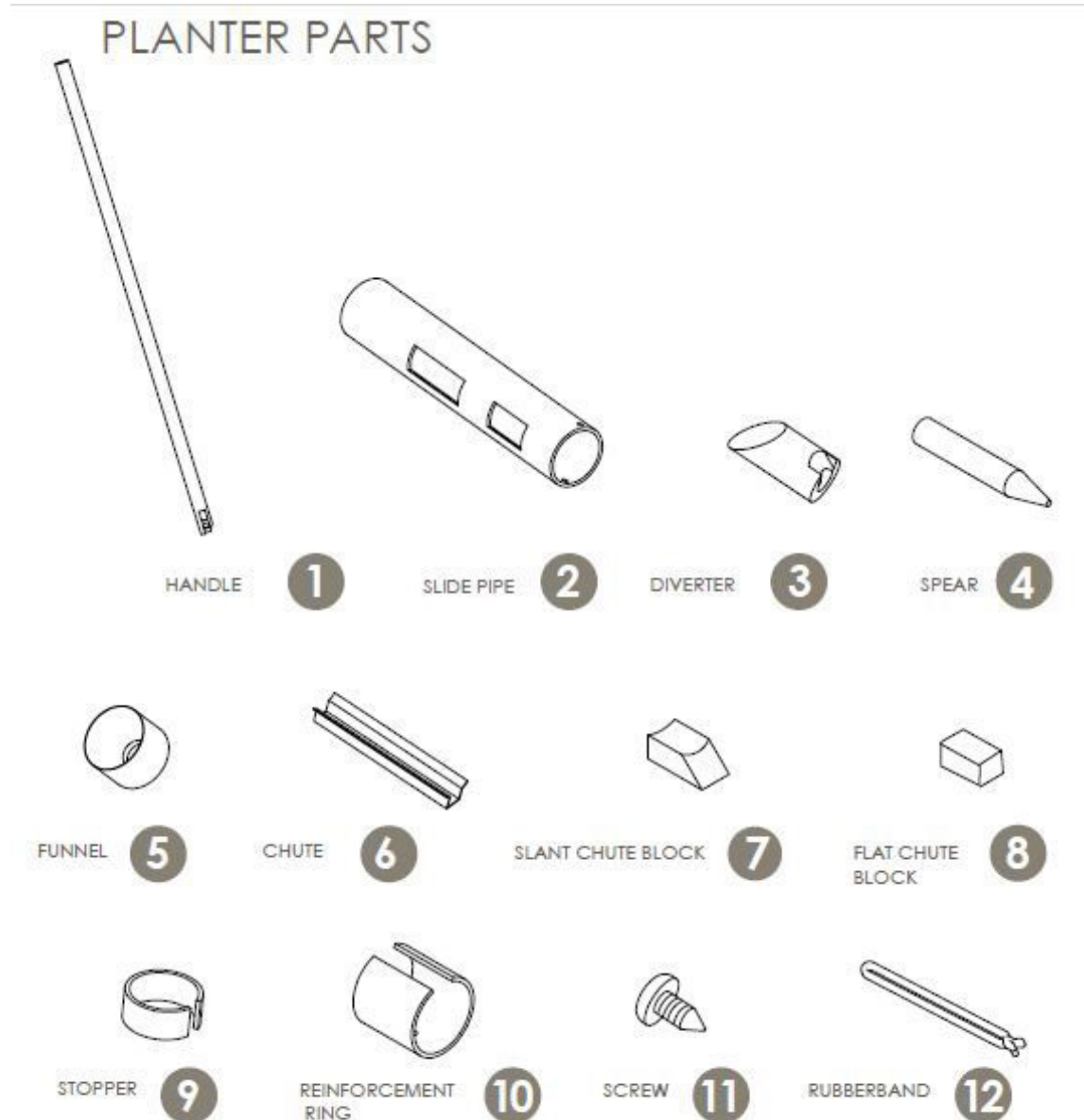

These are the materials in each part and we'll show how to make the parts.

## Materials

Handle: PVC or bamboo

Slide pipe: PVC

Diverter: Wood or bamboo

Spear: Metal rod

Funnel: Wood or bamboo

Chute: Sheet metal

Slant chute block: Wood or bamboo

Flat Chute block: Wood or bamboo

Stopper: PVC

Reinforcement ring: PVC

Screw, rubberband

## Tools

Tape measure

Pencil or marker

Screwdriver

Files

Hammer

Hacksaw

Sheet metal shears

Pliers

## Optional tools

Vice

Angle grinder

power drill

machete

# How to Make a PVC and Bamboo Seed Planter

## Step 2: What It Looks Like

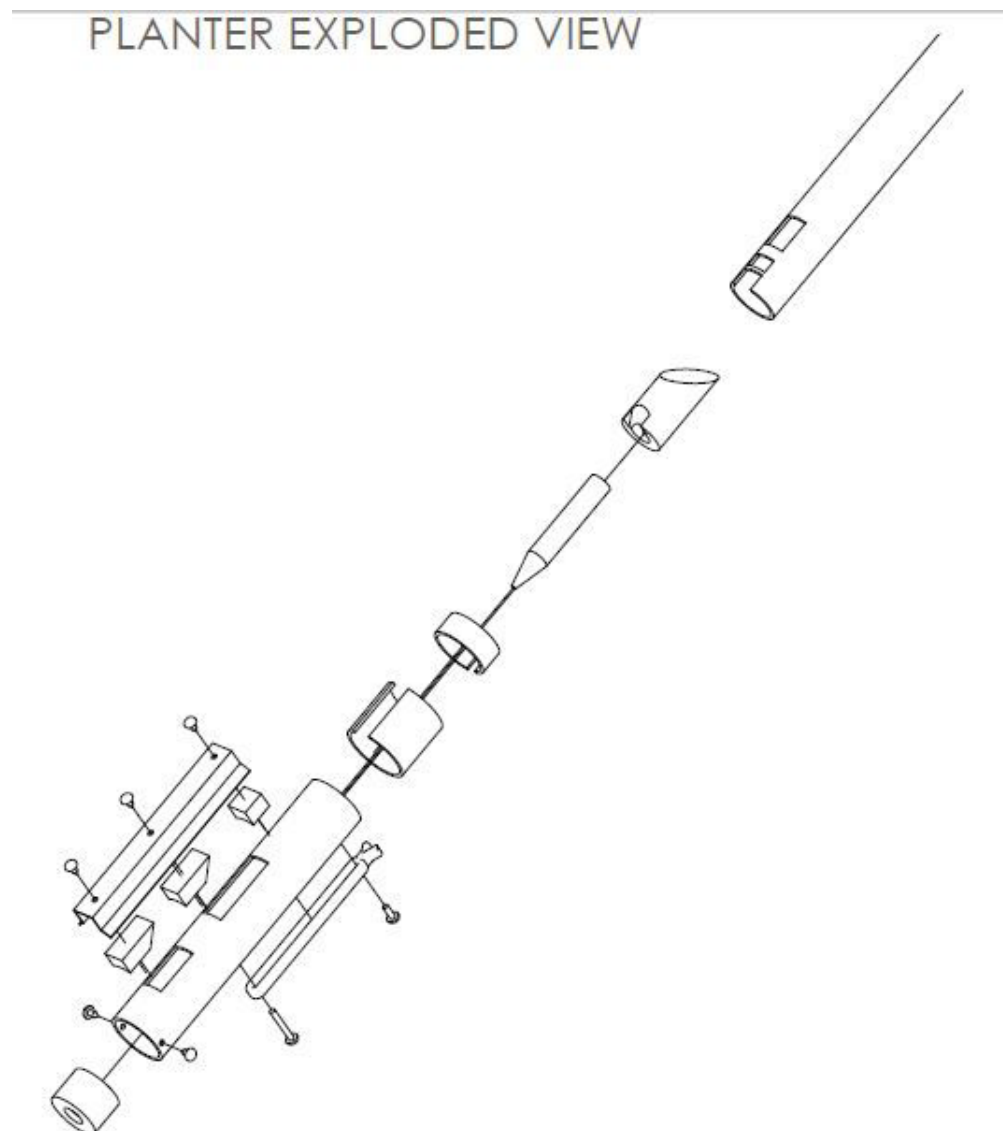

In this series you see the exploded view, the planting mechanism from four different angles, a cut-away view of the seed "counter" inside the mechanism and the last image shows the spring loader in action.

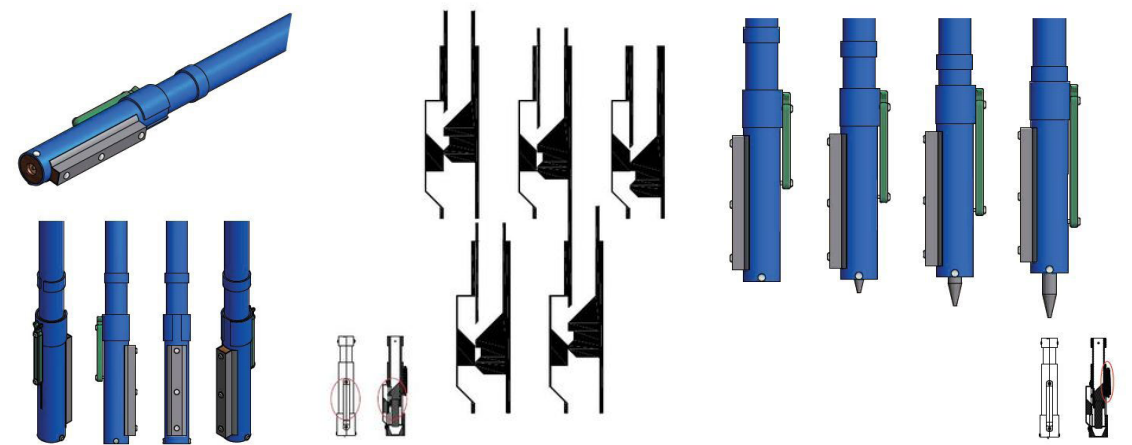

Now to make the parts...

# How to Make a PVC and Bamboo Seed Planter

## Step 3: Handle



Each step corresponds to a photo in order:

1. Measure handle material to person height
2. Draw cross lines to make first window at (1.8 cm, 3 cm). Draw cross lines for second window at (4 cm, 7cm)
3. Measure and draw outside lines ( 2 cm apart)
4. Drill holes inside the edges of the area to be removed
5. Use utility knife and hammer to remove doorway pieces
6. Smooth doorway edges with file
7. You're finished.

On to the slide pipe...

# How to Make a PVC and Bamboo Seed Planter

## Step 4: Slide Pipe

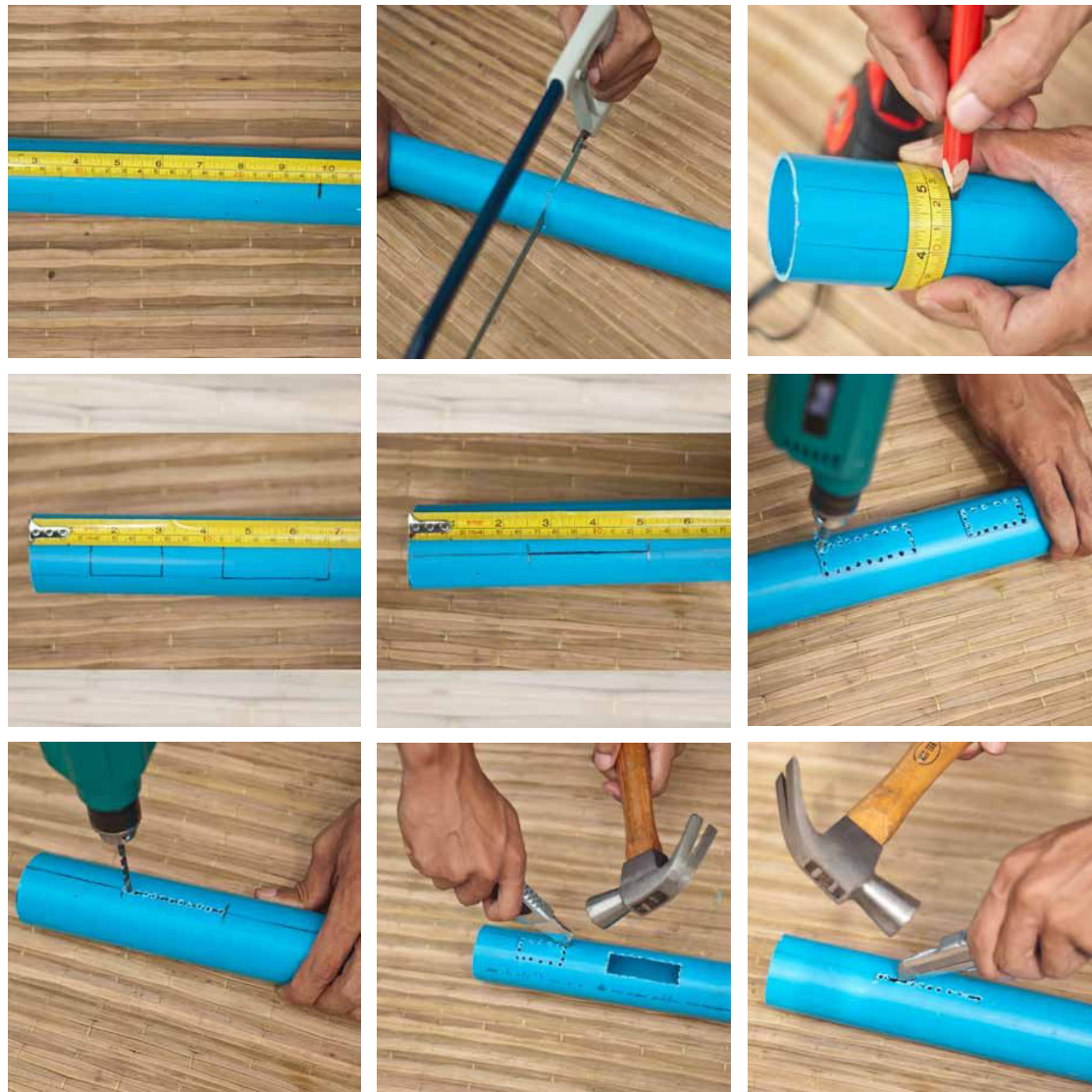

1. Measure slide pipe material to length (25cm)
2. Cut slide pipe material to mark
3. Measure and draw outside lines (2cm apart)
4. Draw cross lines to make first window at (3.5 cm, 7.5 cm). Draw cross lines for second window at (4 cm, 7 cm)
5. Mark line on side opposite doorways for track (6.5 cm)
6. Drill holes inside the edges of the area to be removed for doorways
7. Drill relief holes along line to be removed for track
8. Use utility knife and hammer to remove doorway pieces
9. Use utility knife and hammer to remove bulk material
10. Smooth doorway edges with file
11. Smooth slot edges with file
12. You're finished.

On to the diverter...

# How to Make a PVC and Bamboo Seed Planter

## Step 5: Diverter

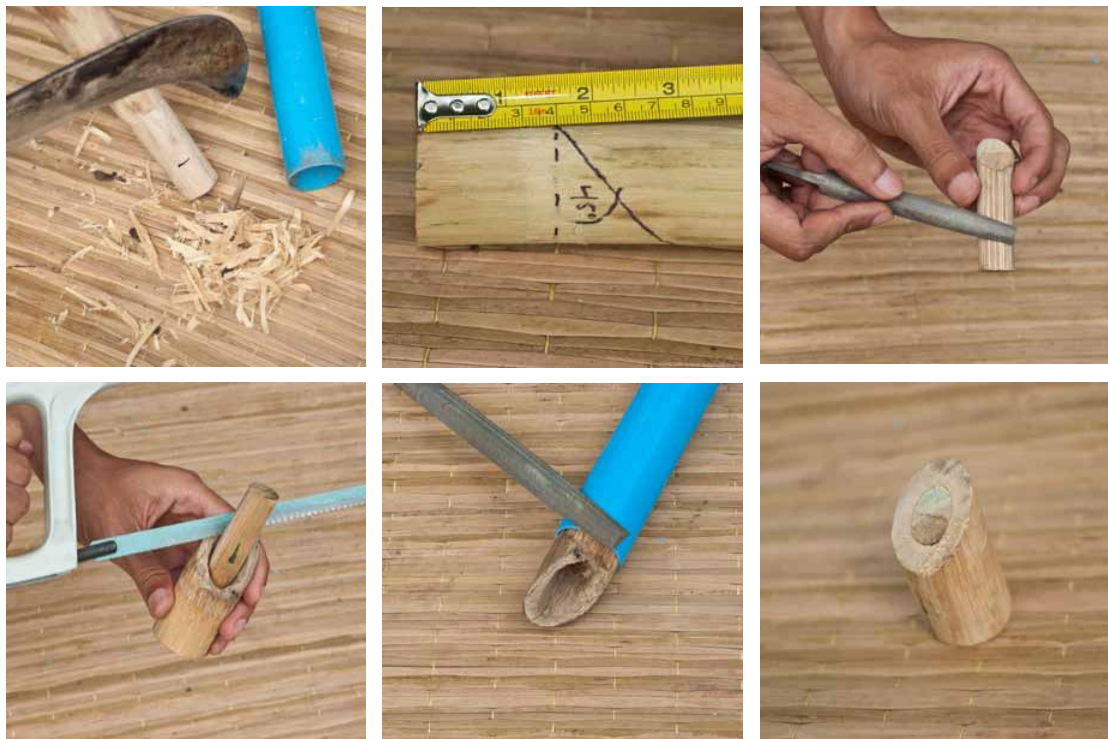

1. Hone wood or bamboo to tightly fit inside the handle
2. Cut at a 45° angle. If using bamboo, make cut above a notch.
3. If using bamboo, make plug to fit in hole above notch
4. Put plug in hole and cut to 45° line.
5. File to fit tight in the handle and tight around the spear
6. You're finished.

Now, on to the spear...

# How to Make a PVC and Bamboo Seed Planter

## Step 6: Spear

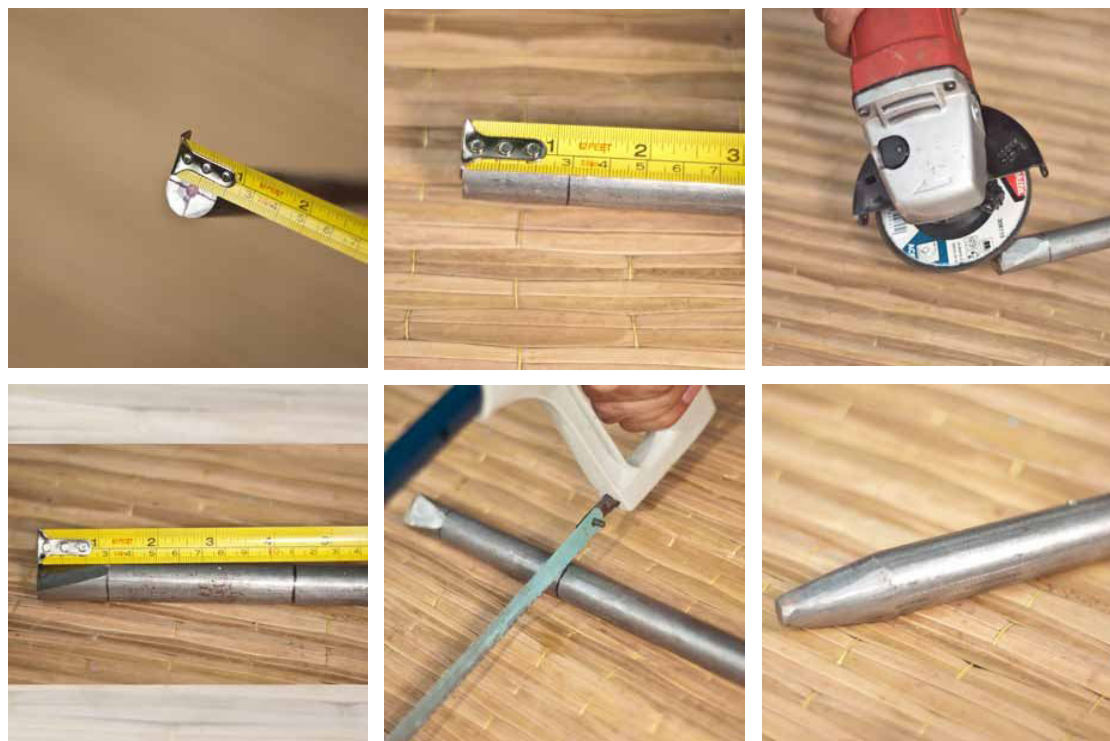

1. Measure the end of the metal to find the center point
2. Measure the length to grind for the point (3cm)
3. Grind one end to make a blunted point around the center point. You can use a grinder or a hack saw.
4. Measure to length (11cm)
5. Cut to length
6. You're finished.

Now, on to the funnel...

# How to Make a PVC and Bamboo Seed Planter

## Step 7: Funnel

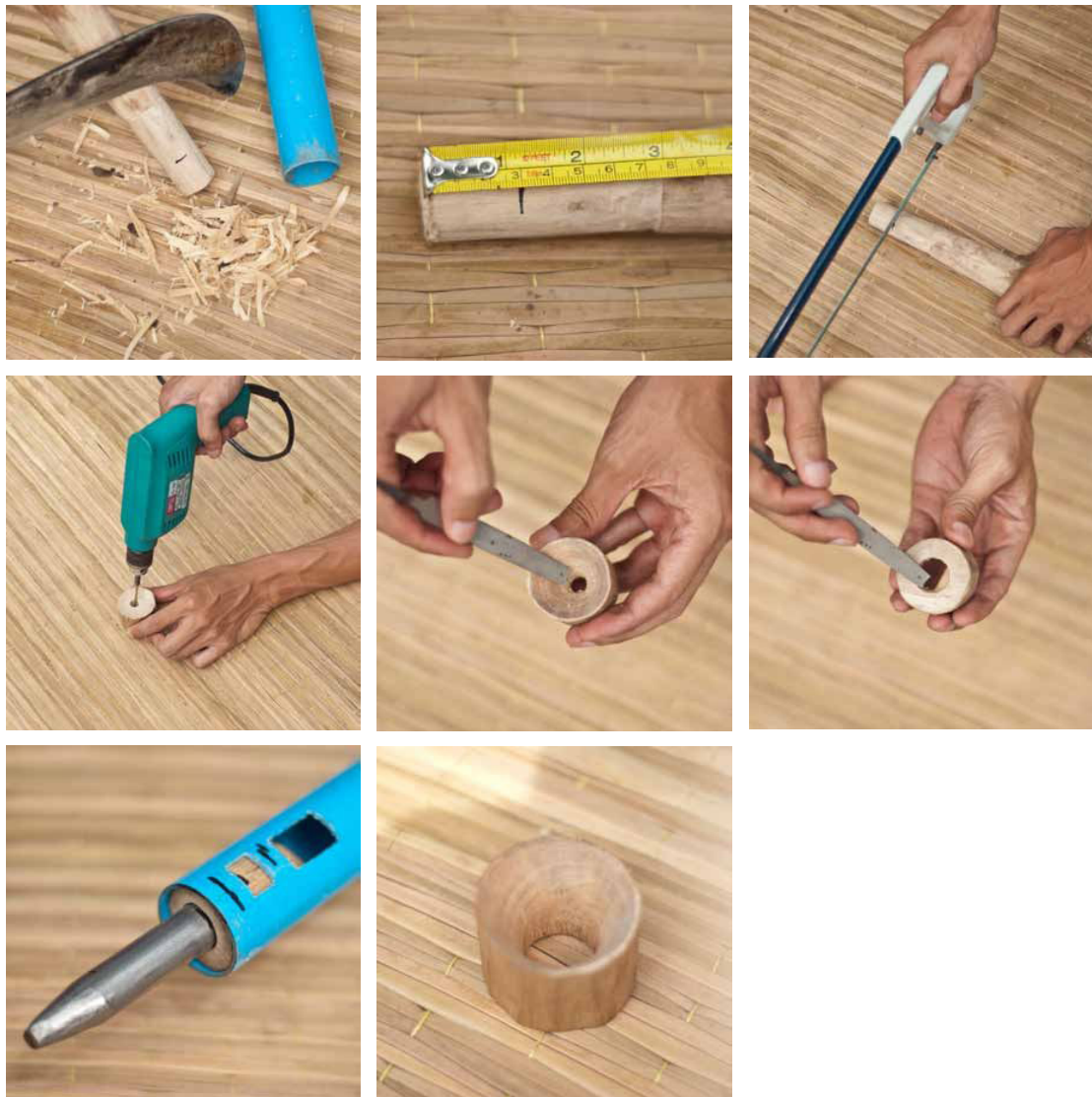

1. Hone the wood (or bamboo) to tightly fit inside the slide pipe
2. Measure it to make sure it's 3cm
3. Cut it to length
4. Drill a hole through the center if you're using wood.
5. Carve the slope of the funnel
6. Carve hole to be able fit spear
7. File to fit tight in slide pipe and loose around spear
8. You're finished.

On to the chute...

# How to Make a PVC and Bamboo Seed Planter

## Step 8: Chute

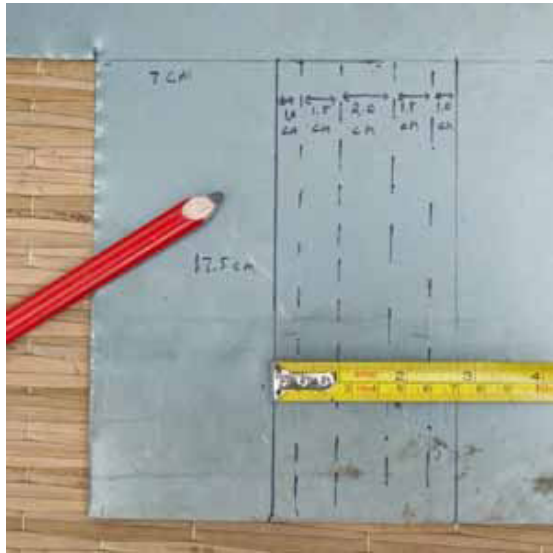

1. Draw the layout on flat sheet metal 17.5cm x (1 cm, 1.5 cm, 2 cm, 1.5 cm, 1 cm)
2. Cut out the sheet metal
3. Bend the cut metal into shape
4. You're finished.

Now you're on to the slanted chute block...





# How to Make a PVC and Bamboo Seed Planter

## Step 9: Slanted Chute Block



1. Draw square dimensions of the chute on a flat surface of wood or bamboo (2 cm)
2. Cut the wood or bamboo along the lines
3. Measure to length on both sides of a 45° angle ( 2 cm on top, 4 cm on bottom)
4. Cut the chute block to length at a 45° angle
5. File to fit it in chute
6. You're finished

On to the flat chute block...

# How to Make a PVC and Bamboo Seed Planter

## Step 10: Flat Chute Block



1. Draw square dimensions of the chute on a flat surface of wood or bamboo (2 cm)
2. Cut the wood or bamboo along the lines
3. Measure to length (2 cm)
4. Cut the chute block to length
5. File it to fit in chute
6. You're finished

On to the stopper...

# How to Make a PVC and Bamboo Seed Planter

## Step 11: Stopper



1. Measure it to length (2 cm)
2. Cut it to length
3. File the inside edge smooth
4. You're finished

On to the reinforcement ring...



# How to Make a PVC and Bamboo Seed Planter

## Step 12: Reinforcement Ring



1. Measure it to length (5 cm)
2. Cut it to length
3. Slit it along its length
4. File the inside edge smooth
5. You're finished

Now to assemble all of the parts...



# How to Make a PVC and Bamboo Seed Planter

## Step 13: Assembly

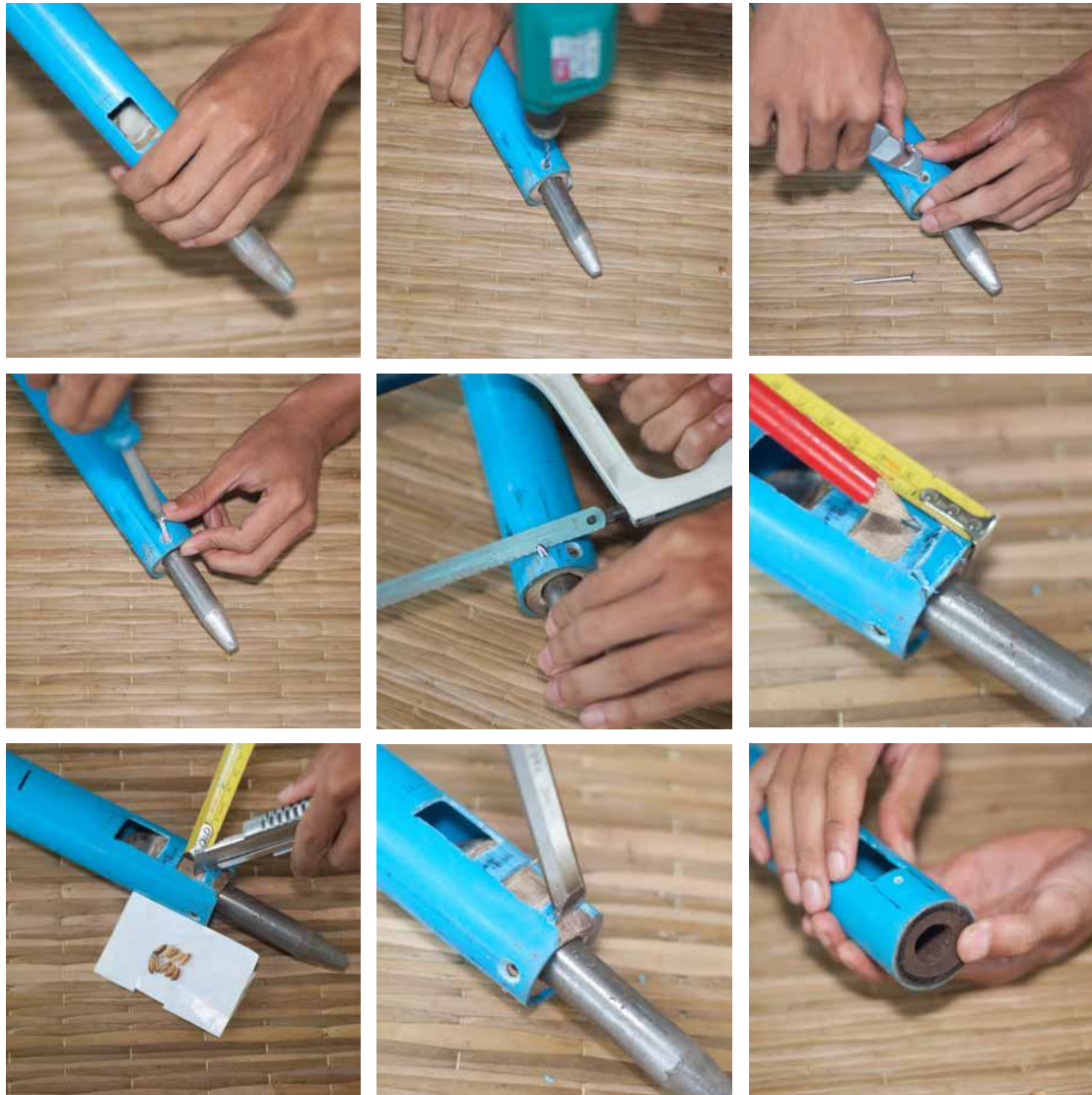

1. Assemble the spear in the diverter in the handle
2. Drill a hole through the handle, diverter and spear but not through the other side of the handle
3. File the edge of the drilled hole on the handle to sink a screw head in the handle
4. Insert a screw through the entire device
5. Cut off the screw tip sticking out
6. Measure the dimensions for the chamber on the handle
7. Gouge out the chamber with a chisel, making sure it holds the amount of seeds or rice desired for each actuation
8. Gouge out the area below the chamber to let the seeds drop more easily
9. Insert the funnel into the slide pipe

# How to Make a PVC and Bamboo Seed Planter

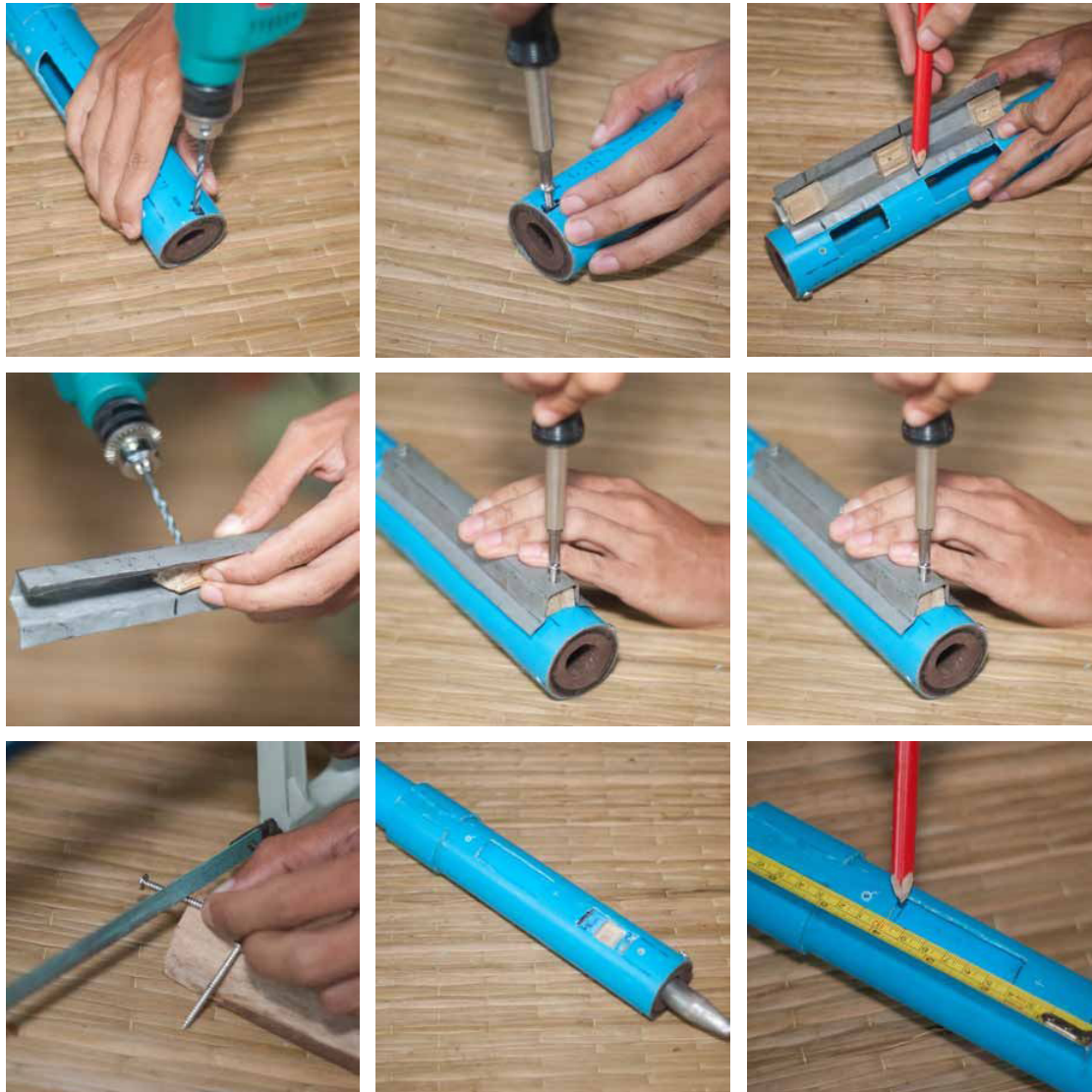

10. Drill two holes through slide pipe into funnel, but not into other side of funnel
11. Insert 2 short screws through slide pipe into funnel
12. Measure the height to put the chute blocks in the chute
13. Drill a hole for each of the three chute blocks
14. Screw center slanted chute block into chute with short screw
15. Screw bottom slanted chute block and top flat chute block into chute using long screw
16. Mark the 2 long screws sticking into slide pipe, remove and cut the screws
17. Insert handle all the way into slide pipe such that the handle contacts the funnel and the windows line up
18. Mark a line 0.2 cm down from the top edge of the top window

# How to Make a PVC and Bamboo Seed Planter



19. Line up the mark with the bottom edge of the bottom window
20. Drill out a hole in the handle at the bottom of the track
21. Drive the screw into the hole so that it sticks out 1cm
22. Mark the handle at the top edge of the slide pipe
23. Slide the slide pipe down and mark the handle 0.1 cm down from the last mark
24. Screw in stopper with bottom edge on the lower mark using a small screw
25. Glue the reinforcing ring on slide pipe flush with the top of the slide pipe
26. Remove the screw from the handle and the slide pipe from around the handle
27. Drive a short screw into the reinforcing ring 1 cm down from the top in line with the slot so that it sticks out 1 cm

# How to Make a PVC and Bamboo Seed Planter

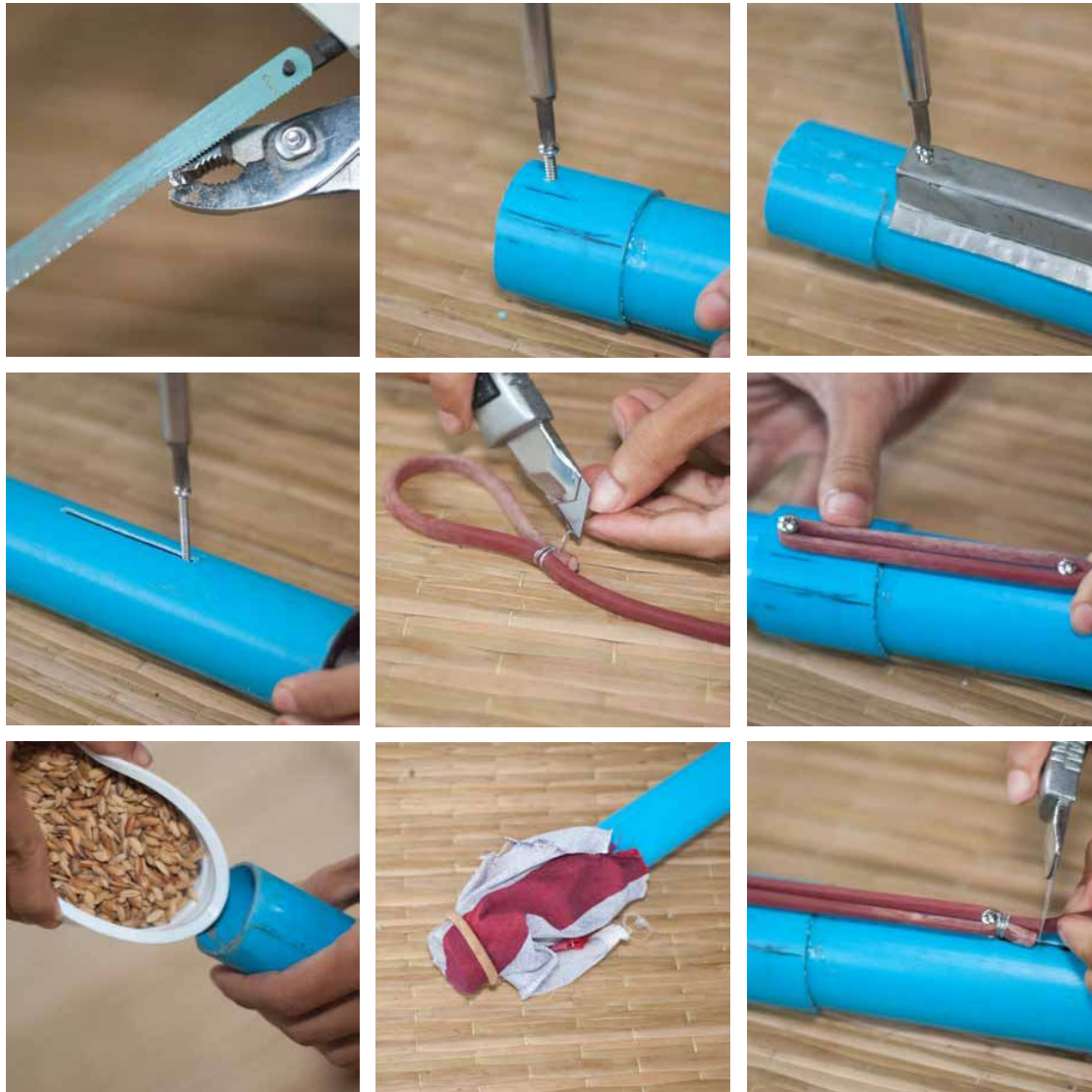

28. Remove screw and cut off the excess that stuck into the slide pipe
29. Replace the screw in the hole
30. Replace the chute on the slide pipe and screw into place
31. Put the slide pipe around the handle and replace the screw in the slot
32. Wrap rubber band around the two screw and pull tight
33. Wrap the wire around the rubber band and cut the excess
34. Cut the excess rubber band
35. Fill the handle with rice
36. Place a PVC cap or a cloth with rubber band on the end as a cap
37. All done!

